

MANUAL

Indoor / Outdoor

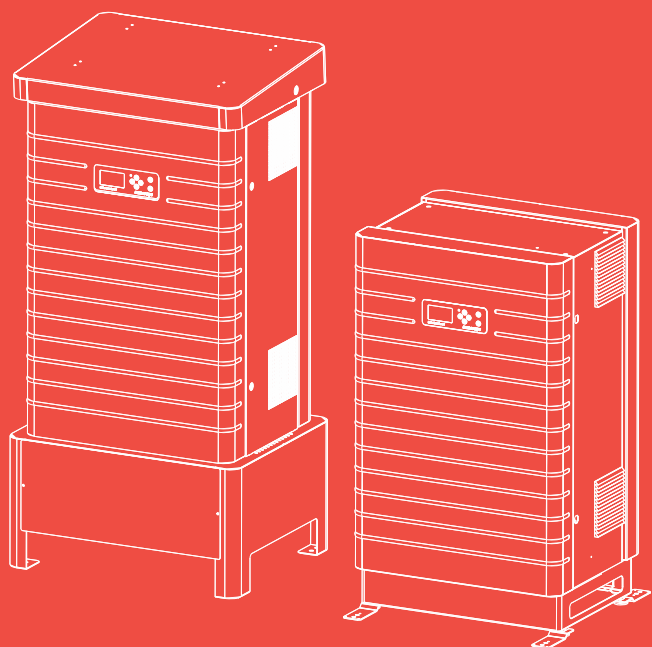

User Manual
Sunways Solar Inverter

PT 30k, PT 33k

english

EN

sunways
Photovoltaic Technology

Sunways AG
Photovoltaic Technology
Macairestraße 3 - 5
78467 Konstanz, Germany

Phone: +49 (0)7531 996 77-0

Fax: +49 (0)7531 996 77-444

E-Mail: info@sunways.de

Internet: www.sunways.de

This user manual may only be reprinted or copied in whole or in part with the express, written approval of Sunways AG. Any type of reproduction, distribution or storage on data carriers in any form and of any kind not authorised by Sunways AG represents a violation of the applicable copyright laws and will be prosecuted. We reserve the right to make technical changes which serve to improve the unit or increase the safety standard, without prior notice.

Publisher responsible for the content: Sunways AG

This user manual contains products and product names which are registered trademarks. The mention of products and product names is used only for information purposes and does not represent product misuse. The passages referring to these products in this user manual do not represent original documentation of the respective product.

Introduction

Thank you for choosing a Sunways Solar Inverter from PT series! You now have an innovative, high-quality product with unique features and consistently high efficiency.

This Solar Inverter is equipped with HERIC[®] topology and innovative PT circuitry and enables operation on a large number of solar modules – as accustomed from Sunways – without the use of a transformer.

This user manual contains instructions for using the PT series. It will help you familiarise yourself with the functionality of the unit. Information is provided on safety, installation, commissioning, operation and system monitoring.

Please follow the safety instructions carefully to enhance health and safety at the operating site of the unit.

	Introduction	3
1	Product description	7
	1.1 Intended use	7
	1.2 Functional description	7
	1.3 Integration into solar system	8
	1.4 Module description	10
	1.5 Delivery scope	11
2	Safety precautions	13
	2.1 General safety precautions	13
	2.2 Explanation of symbols and warnings	14
	2.3 Basic safety measures	15
	2.4 Safety concept	15
3	Technical data	17
4	Installation	19
	4.1 Mechanical installation	19
	4.2 Electrical installation	22
	4.3 Installing the communication equipment	32
5	Commissioning	39
	5.1 Connecting and disconnecting the unit	39
	5.2 Commissioning	40
6	Operation	47
	6.1 General information	47
	6.2 System monitoring	62
	6.3 Sunways Browser	72
7	Maintenance	81
	7.1 Servicing schedule	81
	7.2 Maintenance interval	81
	7.3 Maintenance tasks	81
A	Appendix	83
	A.1 Installation methods and cable cross-sections	83
	A.2 General liability disclaimer	84

1 Product description

1.1 Intended use

The Solar Inverter from PT series is the link between your solar generator and the public power grid. The energy from the connected solar generator is converted to grid-compliant AC current and fed into the grid.

Solar modules which require earthing of the negative or positive terminal cannot be operated with the Solar Inverter PT 30k to PT 33k. If in doubt, always ask your module manufacturer about a release!

1.2 Functional description

Conversion from direct to alternating current	The Solar Inverter PT 30k to PT 33k converts the direct current produced by the solar generator into alternating current. The alternating current is then fed into the public power grid as a three-phase current.
Operating and display elements	<p>Various interfaces are available for system configuration and monitoring:</p> <ul style="list-style-type: none"> • Control panel (LCD display and keyboard) for displaying operating and status values or for inputting system parameters • Operating LED • Integrated web server for display and configuration via a web browser
Interfaces	<ul style="list-style-type: none"> • Bus interface for connecting a Sunways modem, an analog modem, an ISDN modem or a GSM/GPRS modem • Ethernet interface for connecting a PC or for integration in existing networks • RS485 interface for communication with external data loggers • CAN bus interface for interconnecting several Solar Inverter • S0 pulse output for controlling large displays • Activation of large display in web browser • Alarm relay for realising simple monitoring locally • Interface for connecting an irradiance and temperature sensor
Data logging	<p>The Solar Inverter PT 30k to PT 33k offers internal data logging for recording and saving system data:</p> <ul style="list-style-type: none"> • 5-minute mean values of voltages, currents, output, temperature and irradiance (if sensor is installed) • 5-minute, daily, monthly and annual energy yield values • Memory for malfunction messages
Grid monitoring	The Solar Inverter PT 30k to PT 33k assumes the task of grid monitoring for the protection of the unit and persons. In case of abnormal grid conditions, feeding is immediately interrupted and the inverter disconnects from the grid by triggering the grid relay.

Design PT 30k to PT 33k

The basic configuration is shown in the block diagram.

The solar generator voltage connected to the inverter input is initially adapted by the DC actuator and then converted to alternating current by the high-efficiency HERIC® inverter. The AC connection is made with 5 wires due to the 3-phase feed and passive grid monitoring.

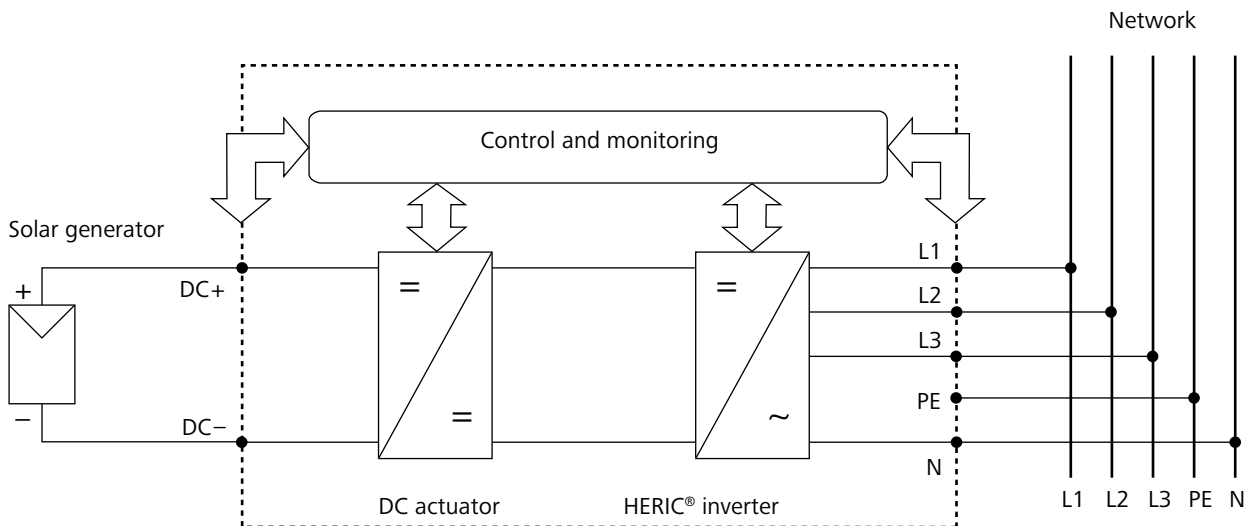

1.3 Integration into solar system

Solar generator configuration

The technical data of the selected solar generator must match the PT 30k to PT 33k specification (see Technical Data). Incorrect dimensioning can lead to reductions in the yield and to destruction of the unit.

The Sundim design program from Sunways can be used for this purpose. Sunways Sundim can be found on the enclosed CD-ROM or on our website at <http://www.sunways.eu/de/>.

Be sure to take the following points into account before planning your system:

- Watch the celestial alignment of the modules. In Central Europe a maximum yield is achieved with a module tilt of 30° to the horizontal and direct south orientation of the solar generator field.
- The cell output decreases as the module temperature increases. Install your solar generator with sufficient ventilation at the rear.
- Check your solar generator approx. every three years for soiling. This occurs especially on the lower edge of the modules and forms a haze that cannot be washed off even by heavy rain. Yield reduction can be prevented by cleaning the modules with a wet cloth or a brush.
- Avoid shading of individual modules or solar cells in your system. This can lead to major reductions in yield.
- Please note the maintenance intervals of the inverter. See servicing schedule on enclosed product CD.

Standard components of a solar system

Depending on the recommendations of your PV planning expert, your PV system consists of the following components:

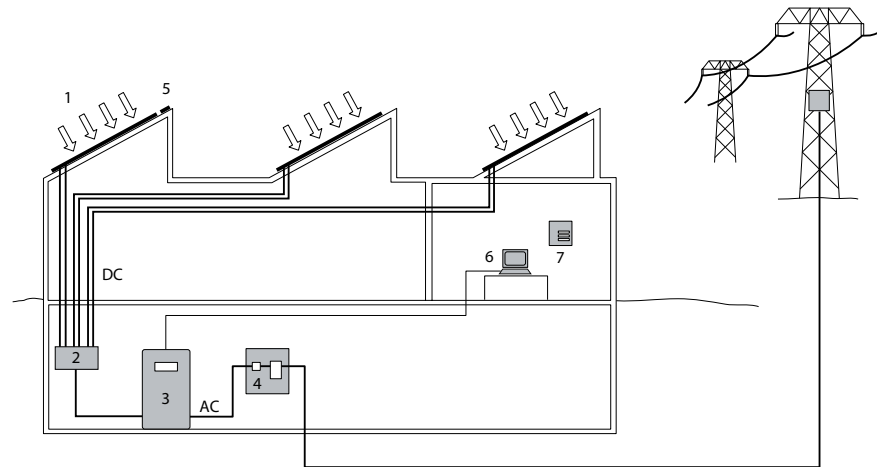

- 1 Solar generator
- 2 Generator connection box (string box)
- 3 Solar Inverter with integrated DC load break switch
- 4 Mains fuse, AFI type B and energy meter

- Options**
- 5 Irradiance sensor with integrated temperature sensor
 - 6 PC for monitoring system
 - 7 Large display

1.4 Module description

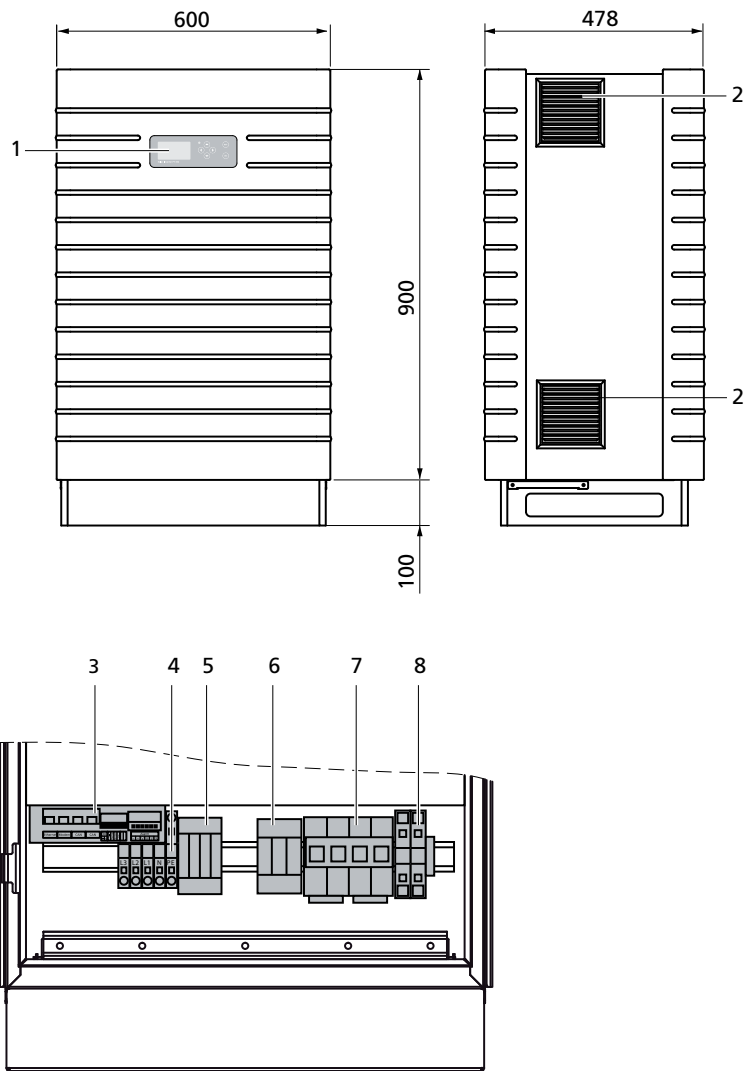

Diagram: IP 42 and IP 54 variants

- 1 Control panel with LCD display, operating LED and console
- 2 Fan guard + filter cartridge
- 3 Communication interfaces

- 4 AC connection
- 5 AC overvoltage protection Cat. II
- 6 DC overvoltage protection Cat. II (optional)
- 7 DC load break switch
- 8 DC connection

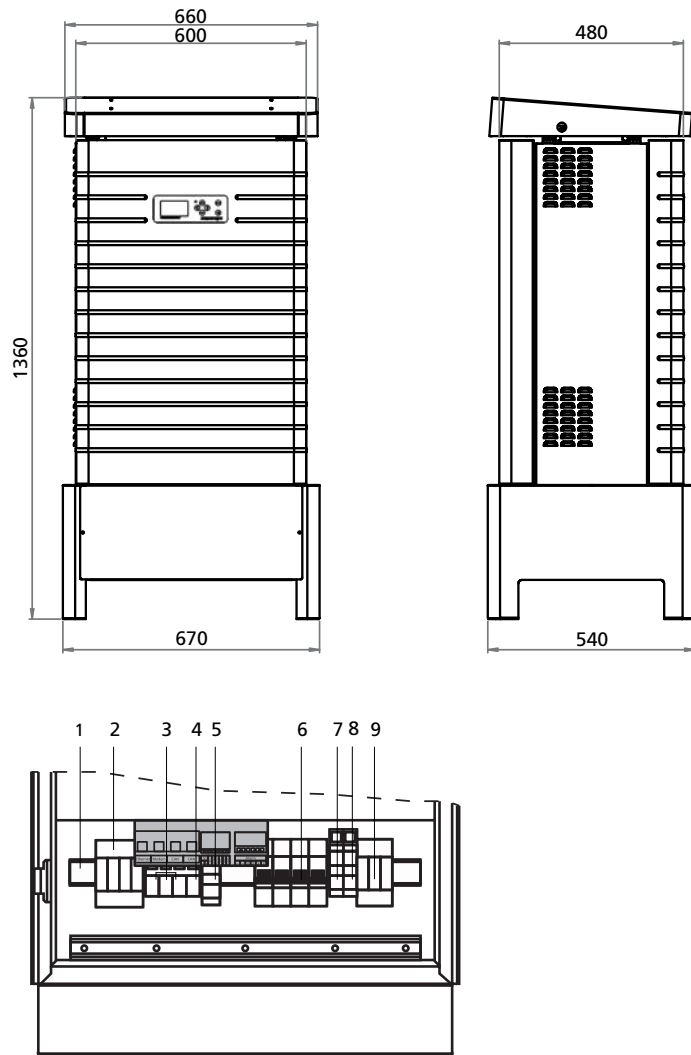

Diagram: IP 55/Outdoor variant

- 1 Mounting rail
- 2 AC overvoltage protection
- 3 AC connection L3, L2, L1
- 4 AC connection N

- 5 AC connection PE
- 6 DC load break switch
- 7 Solar generator Minus
- 8 Solar generator Plus
- 9 DC overvoltage protection Cat. II

1.5 Delivery scope

The delivery consists of:

- Solar Inverter of the PT series
- CAN terminating resistor connector (connected)
- Ethernet cable, 3 m (CAT 5e, 1:1)
- Control cabinet key
- Warranty card
- Installation Instructions - SETUP

Product description

- CD-ROM, including Sunways Sundim design program, product and service information

Checking delivery

Before shipment our products are checked for proper condition. Despite careful, recyclable packing, transport damage may occur, for which the transport company is generally responsible.

Please check the Solar Inverter thoroughly on delivery.

Should you discover damage to the packing or the Solar Inverter, please inform the transport company immediately. Your specialist dealer will be happy to provide assistance if required. Any damage report must be received by the transport company in writing no later than seven days after receipt of the goods.

Note regarding delivery

A "shock watch" is located on the outer packaging and on the inside of the inverter.

Removal of the shock indicator inside the unit is prohibited and immediately voids the guarantee!

Diagram: Shock watch - left: not triggered! Right: triggered!



If the shock watch has been triggered on delivery, please note this on the delivery documentation before you take the unit from the forwarding agent (example: "Shock watch was triggered on delivery") and report the triggered shock watch with identification number and Solar Inverter serial number immediately to the technical hotline.



DANGER

- Never put the unit into operation as it could be functionally damaged.
-

2 Safety precautions

2.1 General safety precautions

Follow the instructions in the operating manual. Safe handling and trouble-free operation of the PT 30k to PT 33k inverter requires knowledge of the basic safety precautions.

This user manual contains the most important information for operating the system safely.

Each person concerned with the installation, commissioning, maintenance and operation of the inverter must have read and understood the entire user manual and, in particular, the chapter entitled Safety Precautions.

In addition, the rules and regulations for accident prevention applicable for the operating site/plant must be observed.

Risks associated with handling the Solar Inverter PT 30k to PT 33k The Solar Inverter has been built in accordance with the state of the art and the recognised safety rules and may only be used

- for its intended purpose and
- in a safe condition.

Improper use may lead to dangers to the life and limb of the user or others, or can adversely affect the system or other property.

In case of malfunctions which can impair safety, the system must be shut down immediately and secured against being switched on again. The malfunction must then be eliminated immediately.

Warranty and liability

The Sunways General Terms and Conditions of Sale and Delivery always apply. Warranty and liability claims for personal injury or damage to property are excluded if they were caused by one or more of the following:

- Improper use of the inverter
- Improper installation, commissioning, operation and maintenance
- Operation of the inverter with defective and/or non-operational safety and protective equipment
- Failure to observe the information in the user manual regarding installation, commissioning, operation and maintenance
- Unauthorised modifications
- Inadequate monitoring of wearing parts
- Improper repairs
- Emergencies caused by external influence or force majeure
- Defective shock indicator
- Faulty operation over a time period of at least one week
- Operation in an unsuitable environment (see classification of air quality)

2.2 Explanation of symbols and warnings

The following warnings and symbols are used to help you quickly understand this manual and safely use the Solar Inverter.

Warnings used in this user manual



DANGER

This symbol indicates an immediate danger which will result in death, injury or serious damage if the applicable safety regulations are not followed.



DANGER

Extreme danger from electric shock!

This symbol indicates an immediate danger from electric shock which will result in death, injury or serious damage if the applicable safety regulations are not followed.



CAUTION

CAUTION

This symbol indicates an immediate danger which can result in damage if the applicable safety regulations are not followed.

Symbols used in this user manual



NOTE

Information

This symbol indicates important information which contributes to a better understanding of the inverter.

Warnings and symbols on unit The following warnings on the inverter housing indicate hazards. Always observe the warnings exactly.



This symbol indicates that the user manual must be read and understood before putting the unit into operation.



Hot surface! The housing can heat up during operation.



Always disconnect the unit from the mains supply and the PV generator before opening the cover. The unit still carries life-threatening voltage for approx. five minutes internally and at the connection terminals of the PV generator following disconnection from the PV generator. The energy storage capacitors are not completely discharged until after this time. You must wait at least five minutes after disconnecting the unit from the mains supply and from the PV generator before opening the unit.

Warning! High leakage current, earth connection essential before connecting supply.

WARNING

High leakage currents. Be sure to make an earthing connection before connecting the power supply circuit (AC system).

2.3 Basic safety measures

All electrical work on the Solar Inverter must be carried out by a qualified electrician while observing the VDE regulations, national and other regulations.

The protective screen and rear wall may only be removed and maintenance may only be carried out by persons who are authorised by Sunways.

When circuit breakers are tripped, the cause of the fault must be determined and eliminated before recommissioning the unit.

Check electrical equipment regularly.

Retighten any loose connections.

Replace damaged lines/cables immediately.

2.4 Safety concept

The following parameters are monitored and displayed continuously and simultaneously by the inverter controller:

- DC overvoltage
- Overvoltage L1, L2, L3
- Undervoltage L1, L2, L3
- Stand-alone operation
- Overfrequency L1, L2, L3
- Underfrequency L1, L2, L3
- Surge error (brief overvoltage L1, L2, L3)
- DC share in AC current L1, L2, L3
- AFI residual current increase > 30 mA
- AFI residual current > 300 mA
- Overtemperature of heat sink, interior, chokes

When a malfunction occurs, feeding is immediately interrupted and the Solar Inverter disconnects from the grid by triggering the mains contactor.

The potential-free alarm relay switches (except for grid undervoltage L1).

The following protective equipment is also provided:

Safety precautions

- Grid-side varistors (class III)
These protect the power semiconductors in case of high-energy, short-term voltage peaks in the grid and dissipate the energy in the choke in case of a grid disconnection.
- Grid-side overvoltage protection (class III)
Protection against atmospheric overvoltages (e.g. caused by remote strikes during thunderstorms).
- Optional grid-side overvoltage protection (class II)
Protection against atmospheric overvoltages (e.g. caused by remote strikes during thunderstorms).

3 Technical data

Model	PT 30k	PT 33k
Article no.	with/without DC overvoltage protection	with/without DC overvoltage protection
IP 42 (pre-configured for Germany)	SI330P11B / SI330P21B	SI333P11B / SI333P21B
IP 54 (pre-configured for Germany)	SI330P31B / SI330P41B	SI333P31B / SI333P41B
IP 55 / Outdoor (EU device)	SI330P20B / SI330P40B	SI333P20B / SI333P40B
DC input		
Rated DC output	31000 W	34500 W
Maximum DC current	75.0 A	
Nominal DC voltage	700 V	
MPP voltage range	420 V to 800 V	460 V to 800 V
Maximum DC voltage	1000 V	
DC connection	2 terminal blocks 16-35 mm ² (outdoor: 16-70 mm ²)	
Number of MPP trackers	1	
Overvoltage category	II (according to DIN VDE 0110 Part1)	
Lightning protection level	SPD Typ 2 (class 2, VDE 0185-305-4) in variant with DC-OVP	
AC output		
Rated AC output	30000 W	33333 W
Maximum AC output	30000 W	33333 W
Rated AC current	43.5 A per phase	48.3 A per phase
Maximum AC current	50.0 A per phase	53.0 A per phase
Nominal frequency	50 Hz	
Frequency range	47.5 - 51.5 Hz (according to DIN VDE 0126-1-1/A1)	
Grid voltage	400 V	
AC voltage range	-20% to +15% (according to DIN VDE 0126-1-1)	
Distortion factor	< 4%	
Power factor (Cos Phi)	1 or configurable between -0.9 and +0.9	
Grid voltage monitoring	Three-phase (according to DIN VDE 0126-1-1)	
Earth fault protection	AFI (AC/DC sensitive) according to DIN VDE 0126-1-1	
Insulation, frequency and DC current monitoring	Integrated according to DIN VDE 0126-1-1	
Required phases for grid connection	3 (L1, L2, L3, N, PE)	
AC connection	5 terminal blocks 16 to 25 mm ² (IP 55/outdoor: 16 to 70 mm ²)	
AC overvoltage category	III (according to DIN VDE 0110 Part1)	
Lightning protection level	SPD Typ 2+3 (class 2+3, VDE 0185-305-4)	

Technical data

Model	PT 30k	PT 33k
Performance data		
Stand-by consumption	< 4 W	
Night-time consumption	< 0.1 W	
Maximum efficiency	98.0 %	98.0 %
Max. European efficiency	97.6 %	97.6 %
MPP efficiency (static)	99.9 %	99.9 %
Circuit type	HERIC® topology, three-phase, transformerless	
Other features		
DC switch according to IEC 60947-1/3	Integrated	
DC overvoltage protection	Depending on variant	
Grid-connection fuse layout	3 x 63 A (16 mm ²) / AFI type B	
Data interfaces	Ethernet, CAN, potential-free signalling relay, S0, modem, RS485	
Sensor interfaces	Irradiance, temperature	
Display	LCD dot matrix, backlit, 128 x 64 pixels	
System monitoring	Automatic alarms via e-mail, Sunways browser, Sunways portal	
Power supply unit protected on PCB	T2A/250 V	
IP rating according to IEC 60529	IP 42 / IP 54 (outdoor: IP 55)	
Max. relative humidity	95% / non-condensing	
Air quality according to EN 60721-3-4	for mechanical active substances: 3S1-IP 42, 3S2-IP55/Outdoor for chemical active substances: 4C1-IP42, 4C1-IP55/Outdoor	
Climate class	4K4H (in accordance with EN 60721--4)	
Maximum height above sea level	1000 m	
Cooling	Forced cooling by fan (fresh air supplied: approx. 350 m ³ / hour)	
Ambient temperature	-20°C to 40°C (to 50°C with derating)	
Stiffening plates on the sides	for installations in direct sunlight (optionally available, Art.Nr.SE104M10A)	
Overload characteristics	Operating point offset	
Dimensions (height x width x depth)	100 x 60 x 48 cm (outdoor: 136 x 67 x 54 cm)	
Weight	approx. 155 kg (outdoor: approx. 170 kg)	
Installation type	Standing installation	
Noise level	Approx. 70 dBA (outdoor: approx. 76 dBA)	
Standard warranty (option)	5 years (with service contract: up to 20 years)	
Certificates	CE, DIN VDE 0126-1-1/A1, RD 1663/2000, RD 661/2007, CEI 11-20 v.1, Sezione F Guida Enel, BDEW Medium Voltage Directive and February 2011 addendum, TR 3 (REV. 21) and TR 8 (Rev. 4)	

4 Installation

4.1 Mechanical installation

Requirements for installation location



DANGER

- The Solar Inverter may not be installed in areas subject to explosion hazards.
- The Solar Inverter may not be exposed to corrosive gases.
- No combustible materials must be stored within 3 metres of the solar inverter.

Protection against moisture and foreign bodies

- The PT 30k to PT 33k application range varies according to model.

The IP 42 variant is suitable for indoor installation. The air quality must at least correspond to Class 3S1 for mechanically active substances as well as Class 4C1 for chemically active substances.

The IP 54 variant can be used for the roofed outdoor area. The air quality must at least correspond to Class 3S2 for mechanically active substances as well as Class 4C1 for chemically active substances.

The IP 55/Outdoor variant allows outdoor installation. If possible, use a roof-covered area protected from rain and dust as an installation location and avoid direct sunlight. The air quality must at least correspond to Class 3S2 for mechanically active substances as well as Class 4C1 for chemically active substances.

Stiffening plates on the sides optionally available.

Classification of air quality for mechanically active substances (acc. to EN 60721-3-4)

Environmental conditions for site-specific use	Class			
	3S1	3S2	3S3	3S4
a) Sand in air [mg/m ³]	-	30	300	3000
b) Dust (suspended matter content) [mg/m ³]	0.01	0.2	0.4	4.0
b) Dust (rainfall) [mg/m ³]	0.4	1.5	15	40
Locations where the occurrence of dust is kept to a minimum through appropriate measures.	x	x	x	x
Locations where no special measures for reducing the sand or dust occurrence have been taken and are not close to sand.		x	x	x
Locations close to sources of sand or dust.			x	x
Locations in production facilities where there is no sand or dust, or locations in geographical regions where a higher proportion of sand and dust can occur in the air.				x

Classification of air quality for chemically active substances (acc. to EN 60721-3-4)

Environmental conditions for site-specific use	Class						
	4C1	4C2		4C3		4C4	
	Limit	Average	Limit	Average	Limit	Average	Limit
a) Sea salt	Occurrence of salt spray						
b) Sulphur dioxide, mg/m ³	0.1	0.3	1.0	5.0	10	13	40
c) Hydrogen sulphide, mg/m ³	0.01	0.1	0.5	3.0	10	14	70
d) Chlorine, mg/m ³	0.1	0.1	0.3	0.3	1.0	0.6	3.0
e) Hydrogen chloride, mg/m ³	0.1	0.1	0.5	1.0	5.0	1.0	5.0
f) Hydrogen fluoride,	0.003	0.01	0.03	0.1	2.0	0.1	2.0
g) Ammonia, mg/m ³	0.03	1.0	3.0	10	35	35	175
h) Ozone, mg/m ³	0.01	0.05	0.1	0.1	0.3	0.2	2.0
i) Nitrogen oxides, mg/m ³	0.1	0.5	1.0	3.0	9.0	10	20
Locations in rural or also densely populated regions with little industry or moderate traffic density.	x	x		x		x	
Locations in densely populated regions with industry and high traffic density.				x		x	
Locations in the immediate vicinity of industrial plants with chemical emissions.				x		x	
Locations inside industrial plants, emissions of dangerous chemical substances in high concentrations.						x	

Mechanical load-bearing capacity

- Note during installation that the Solar Inverter weighs 155 kg or 170 kg (IP 54/Outdoor variant). The installation surface must be firm and able to carry this weight in the long term. A concrete foundation is recommended.

Thermal interaction

- The installation surface and the rear and side walls of the installation site must consist of flame-retardant material (not suitable: surface of wood or plastic; suitable: e.g. concrete), as the frame of the PT 30k to PT 33k can heat up to a maximum of 85°C.
- A minimum distance of 1 m to other units, cabinets, ceilings, cable ducts, etc. must be maintained to the sides of the housing. A distance 0.3 m must be maintained from the rear wall of the PT 30k to PT 33k for service purposes (see diagram).

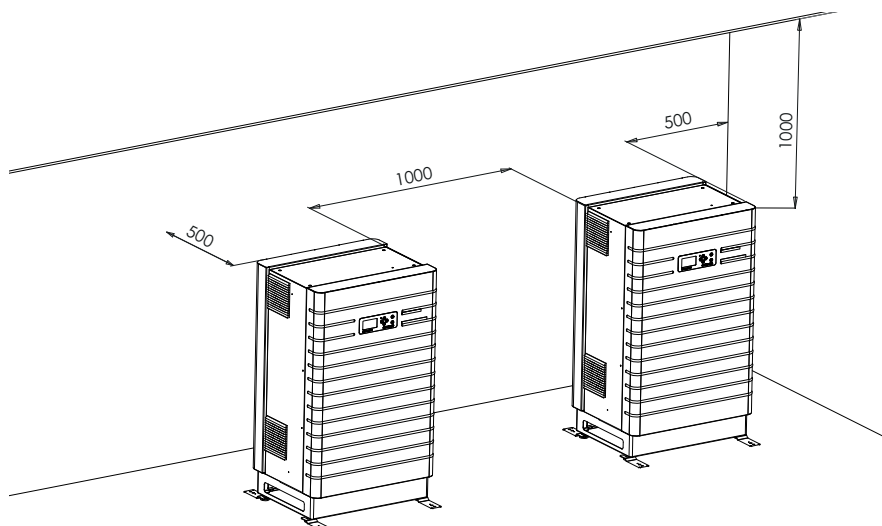

- The Solar Inverter must be installed upright to enable adequate free convection.
- Solar Inverter may not be stacked in order to prevent excessive warming.
- If several PT Solar Inverter are operated in an enclosed space, adequate fresh air supply must be ensured. Larger systems should be configured in collaboration with Sunways at the design stage.
- The ambient temperature must be between -20 °C and +40 °C. At ambient temperatures above 40°C, the Solar Inverter automatically regulates its output downwards.
- The IP 42 and IP 54 variants should not be exposed to direct sunlight to protect them from unnecessary external warming. The outdoor version is protected by a sun shade for operation in direct sunlight.

Installation (IP 42, IP 54 variants)

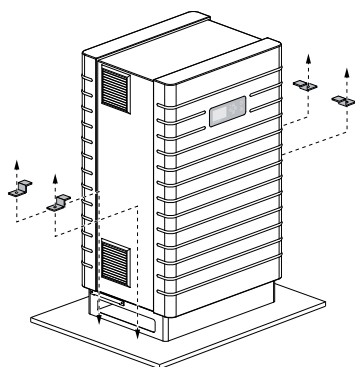

For Solar Inverter installation, proceed as follows:

1. The Solar Inverter is attached to the pallet with retaining claws. Remove the retaining claws.
2. Use a trolley for transporting the unit to the installation site.
3. Use the retaining claws to secure the Solar Inverter on the installation surface.

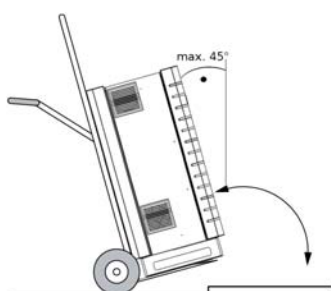

Do not subject inverters to extreme shocks, otherwise the internal shock indicator will be activated (>25 g acceleration) and the unit guarantee thus rendered void.

Installation (IP 55/Outdoor variant)

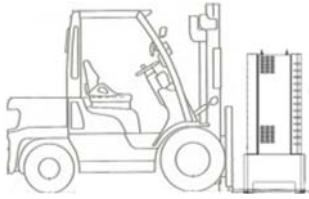

Proceed as follows to install the PT 30k to PT 33k outdoors:

1. The Solar Inverter is attached to the pallet with retaining claws. Remove the retaining claws.
2. Use a forklift truck, a wheel loader or crane to transport the unit to the installation site.
3. Secure the Solar Inverter on the installation surface (e.g. on a concrete base) with the screws included in the delivery contents. Use the pressed-on hole template in the cover for this.



Do not subject inverters to extreme shocks, otherwise the internal shock indicator will be activated (>25 g acceleration) and the unit guarantee thus rendered void.

4.2 Electrical installation

Cable installation (IP 42, IP 54 variants)



DANGER
Extreme danger from electric shock!

- Touching live parts can result in death.
 - All electrical work must be carried out by a qualified electrician while observing the VDE regulations, national and other regulations.
-



DANGER

- For units with cable entry terminals that are installed externally or in rooms where small rodents are to be expected (e.g. mice in factory buildings), the installation of rodent protection is obligatory. Otherwise the warranty becomes void.
 - Even with installation of the rodent protection, a rodent infestation cannot be 100% excluded.
 - Rodent protection is only included as standard in the IP54 variant. For the IP 42 variant, it can, however, also be ordered and retrofitted separately (Art. No. SE103M10A).
-

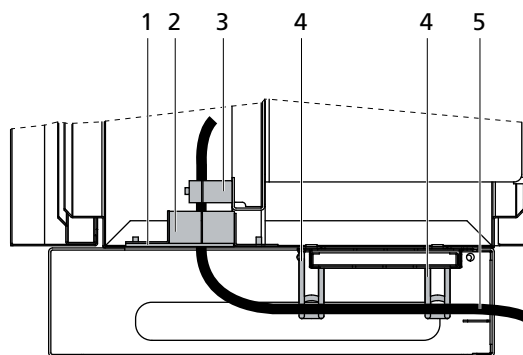

- | | |
|---|-------------------------|
| Cable installation IP 42, IP 54 | 2 Bars with foam rubber |
| 1 Rodent protection (only included as standard in the IP54 variant) | 3 Strain relief device |
| | 4 Cable brackets |
| | 5 Cable |

Proceed as follows with the cable installation for the IP 42 and IP 54 variants:

1. Release the screws of the foam strips, push them apart and remove the front part of the foam strip.

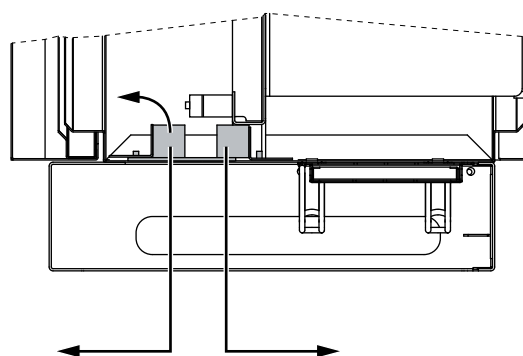

2. Remove the rodent protection. Note the mounting position!

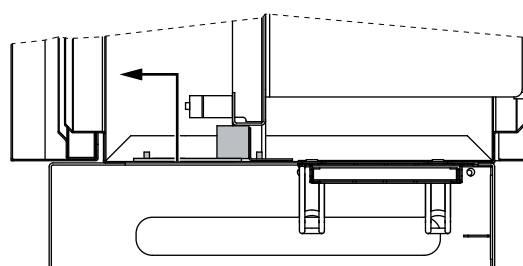

3. Only bend the punch-outs on the rodent protection, which are needed for the cable. To ensure the cable can optimally fitted, remove just the half of a punch-out where necessary.

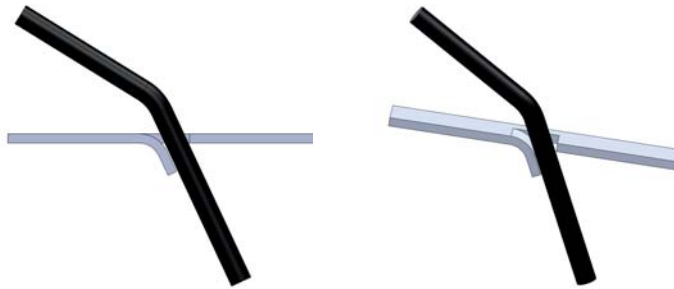

DANGER

Use a tool (e.g. pliers) to bend the punch-outs in order to avoid injury.



NOTE

The individual ribs of the rodent protection should be bent along the length of the cable and should **not be broken!**

4. Configuration of the rodent protection:

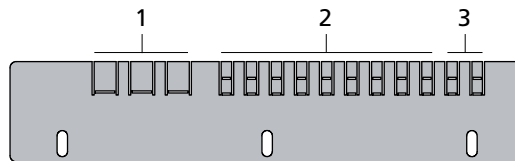

- 1 Punch-outs for AC cables
- 2 Punch-outs for interface cables
- 3 Punch-outs for DC cables

5. Guide the cable on the Solar Inverter back over the cable brackets through the opening of the unit in front of the rear foam strip.

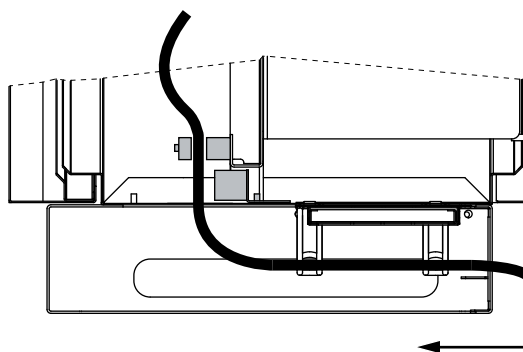

- 6. Open the strain relief device and guide the cables through it.
- 7. Install the cables (see Solar generator connection and Grid connection).
- 8. Pull the cables back slightly and re-attach them with the strain relief device.

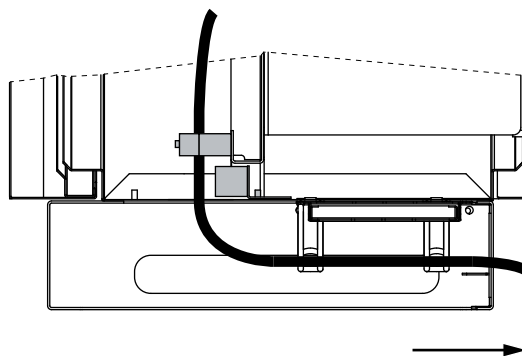

9. Re-insert the rodent protection in the unit housing. Note the correct mounting position and ensure that the cables are routed exactly through the bent punch-outs.

10. Replace the front part of the foam strip.

11. Push the bars back together and secure them with the bolts.

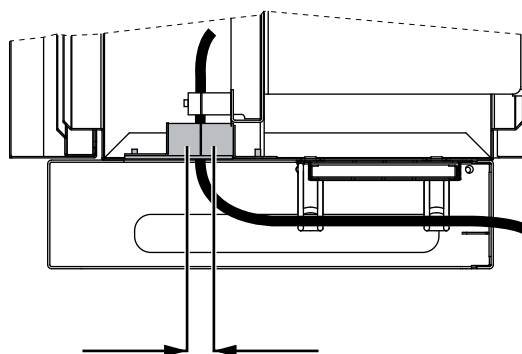

Cable installation (IP 55/Outdoor variant)



DANGER

Extreme danger from electric shock!

- Touching live parts can result in death.
- All electrical work must be carried out by a qualified electrician while observing the VDE regulations, national and other regulations.



NOTE

Correct cable installation

- The unit only meets all requirements of housing protection class IP 54/Outdoor if all cable entries have been screwed in properly.
- In the case of unused cable entries, the connection area must be closed with the blank plugs included.
- Unclosed openings in the connection box of the unit can lead to damage caused by moisture, dust or animals. This renders the guarantee void!

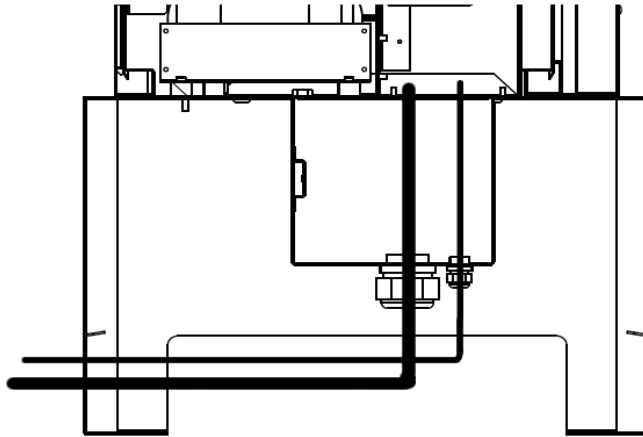

Fig. 1: IP 55/Outdoor illustration: Cable entry

Solar generator connection



DANGER

Extreme danger from electric shock!

- Touching live parts can result in death.
- All electrical work must be carried out by a qualified electrician while observing the VDE regulations, national and other regulations.
- Execute the direct current wiring in accordance with the system dimensioning of your planning expert.
- Prepare all solar generator cables before connecting the solar generator to the Solar Inverter.
- Check each solar generator string for proper operation with an open-circuit voltage and short-circuit current measurement before connecting the string to the inverter.
- Check the rating plate on the Solar Inverter to ensure that it is approved for the maximum solar generator voltage.
- The positive and negative lines must be kept electrically separate from the earth potential.
- Touchable, live parts of the solar generator (e.g. metal frame, carrying structure, etc.) must be earthed (connection with PE).
- Check the solar generator for freedom from short-circuits to earth.
- Before connecting the solar generator to the Solar Inverter, open the integrated DC load break switch (position 0).
- After the solar generator is connected to the Solar Inverter and the DC load break switch is switched on, the direct generator voltage is present internally.
- Always disconnect the mains connection first by switching off the corresponding mains fuse and before disconnecting the solar generator side by opening the DC load break switch.

Overview

The solar generator can be directly connected to the Solar Inverter with a string. Use the DC terminals that are accessible from inside for the connection.

**NOTE**

- The solar generator strings running to the string box must be identically dimensioned and comply with the specifications of the Solar Inverter.
- No external DC load break switch is required. A DC load break switch as required in accordance with DIN VDE 0100-712 is integrated in the Solar Inverter.

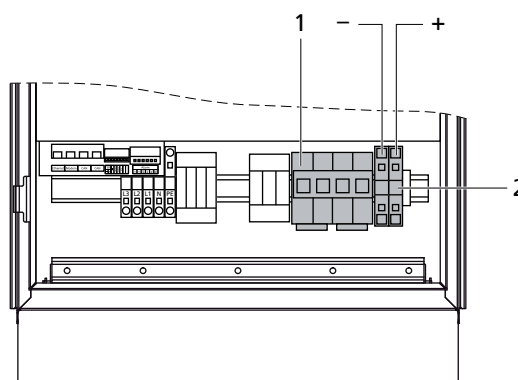
**Diagram: IP 42, IP 54 variants**

1 DC load break switch

2 Solar generator connection

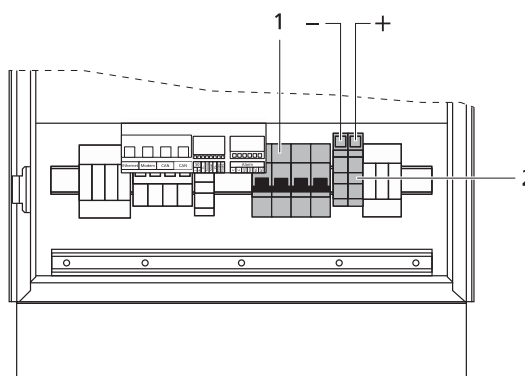
**Diagram: IP 55/Outdoor variant**

1 DC load break switch

2 Solar generator connection

Installation

**DANGER****Extreme danger from electric shock!**

- Touching live parts can result in death.
- All electrical work must be carried out by a qualified electrician while observing the VDE regulations, national and other regulations.
- Ensure that the cables are installed securely.



NOTE

- Any kind of soiling (dust, moisture, etc.) has a negative effect on the terminals with regard to function over the intended period of use.
- DC connection cables with cross-sections between 16 mm² and 35 mm² or between 16 mm² and 70 mm² for (Outdoor) are permitted.
- The copper cables must be double-insulated and UV-resistant ("Radox" cables from Huber & Suhner, for example, are suitable).

The following sequence must be observed during assembly:

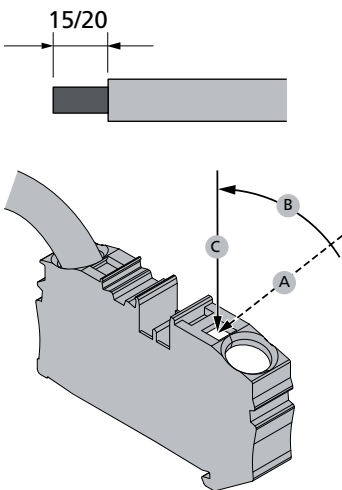

1. Strip the voltage-free line.
 - with end splice 15 mm
 - without end splice 20 mm
2. Apply a screwdriver at a slant (A) to the locking device and push it in until it is vertical (B). The screwdriver then locks it in place (C).
3. Introduce the stripped cable into the cable clamp and push the screwdriver forward into the original position.

The following sequence must be observed during assembly:

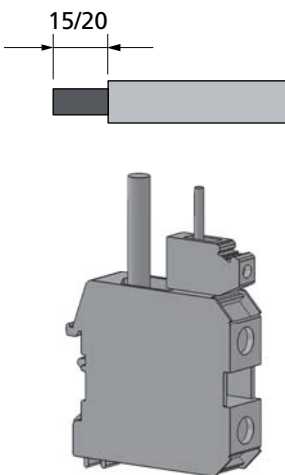

1. Strip the voltage-free line.
2. The IP 54/Outdoor variant has screw terminals. These are fully suited for copper cables from 16 mm² to 70 mm². The screws to the terminal blocks must be tightened with a torque of 6-8 Nm. The use of aluminium cables is only possible for cross sections of 35 mm² -70 mm². Please observe the specifications of the cable/cable socket manufacturer (removal of oxide layer, use of Vaseline or grease).



CAUTION

Please avoid squeezing the cable insulation or the end splice. Improper connection may damage the equipment!

String box

The string box enables connection of up to 8 or 12 solar generator strings to a DC bus line that can be connected directly to the Solar Inverter.

The string box has protection rating IP65 and can therefore also be installed near the solar generator. The string box can be equipped with fuses or dummy sleeves. Pay attention to correct installation of metric cable glands and blind

caps as otherwise the watertightness of the IP65 is not guaranteed.

String box options

The Sunways string box is available with the following options:

- for up to 8 or up to 12 PV strings
- with/without DC overvoltage protection
- with/without DC load break switch
- fuses for different currents
- CAN string box incl. string monitoring
- Dummy sleeves

Further information can be found in the Solar Inverter Accessories section at www.sunways.de.



DANGER

- First disconnect the solar generator incl. string box with the aid of the DC load break switch of the inverter. Only then open the string fuses. Opening of the string fuse under live conditions can lead to life-threatening arcing!
-

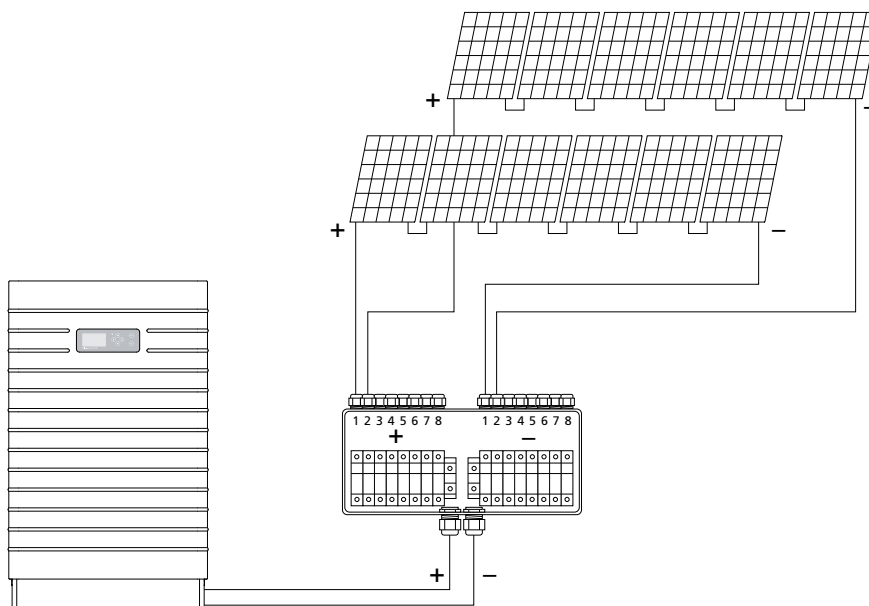

Mains connection



DANGER

Extreme danger from electric shock!

- Touching live parts can result in death.
- All electrical work must be carried out by a qualified electrician while observing the VDE regulations, national and other regulations.

- Note the AC terminal assignment. An incorrect assignment can result in the unit being destroyed.
- No consumers may be connected to the supply line from the Solar Inverter to the mains fuse.
- Always disconnect the mains connection first by switching off the corresponding mains fuse and before disconnecting the solar generator side by opening the DC load break switch.



NOTE

If the voltage on the AC connection exceeds the permissible value due to a long line length or an insufficient cable cross-section, the Solar Inverter will be disconnected from the mains. In power grids with a low capacity and a high solar generator output, this can lead to individual Solar Inverter being switched off and then on again several times.

Overview

An AC terminal strip on the underside of the unit is used for the five-wire grid connection (L1, L2, L3, N, PE) of the solar inverter. Feeding is always three-phase via the AC terminal.

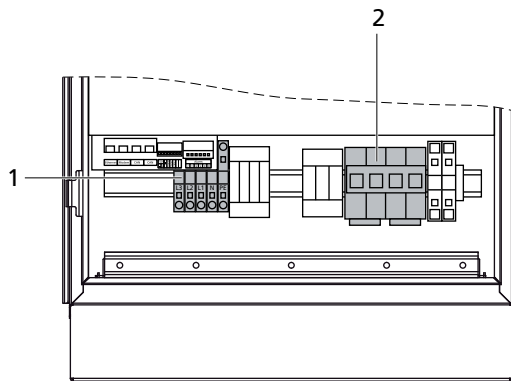

Diagram: IP 42, IP 54 variants

1 AC connection

2 DC load break switch

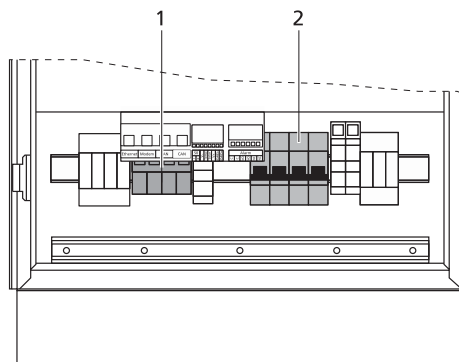

Diagram: IP 55/Outdoor variant

1 AC connection

2 DC load break switch

The unit is centrally earthed using PE terminals. No separate earthing of the solar generator is required.

A corresponding circuit breaker is recommended as a line protection element in the grid feed direction:

3 x 63 A with slow-blow characteristic C
(for connection cross-sections $\geq 16 \text{ mm}^2$)

A three-pin circuit breaker or individual fuses can be used. Protection is implemented according to the installation method. A guide is provided in the appendix.

An AFI type B must be installed at the mains.

The AC power distribution incl. mains fuse should be placed as close as possible to the inverter.

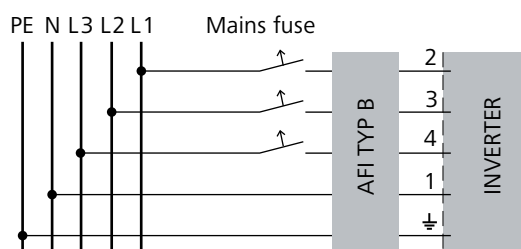

NOTE

- A three-phase meter must be used.
- Some grid operators require the use of a reverse-current-capable meter.

Installation



DANGER

Extreme danger from electric shock!

- Touching live parts can result in death.
- All electrical work must be carried out by a qualified electrician while observing the VDE regulations, national and other regulations.
- Note the AC terminal assignment. An incorrect assignment can result in the unit being destroyed.
- Ensure that the cables are installed securely.



NOTE

- Any kind of soiling (dust, moisture, etc.) has a negative effect on the terminals with regard to function over the intended period of use.
- The following cross-sections are recommended as suitable AC connection cables for power lengths of up to 50 m.
 - 16 mm² solid copper cable
 - 16 mm² flexible copper/non-metallic sheathed cable

Installation

The following sequence must be observed during assembly:

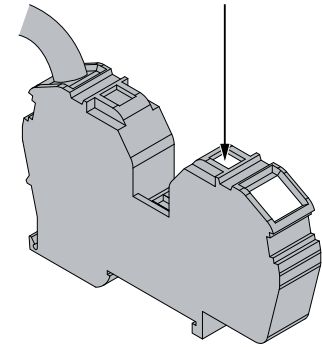
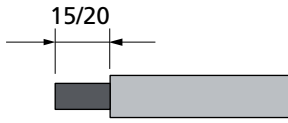

1. Strip the voltage-free line.
 - with end splice 15 mm
 - without end splice 20 mm
2. Introduce a screwdriver vertically into the locking device.
3. Introduce the stripped cable into the cable clamp and pull the screwdriver out again.

The following sequence must be observed during assembly:

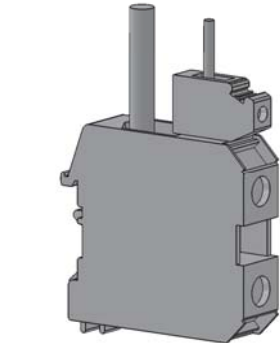
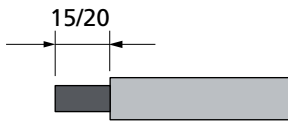

1. Strip the voltage-free line.
2. The IP 55/Outdoor variant has screw terminals. These are fully suited for copper cables from 16 mm² to 70 mm². The screws to the terminal blocks must be tightened with a torque of 6-8 Nm. The use of aluminium cables is only possible for cross sections of 35 mm² - 70 mm². Please observe the specifications of the cable/cable socket manufacturer (removal of oxide layer, use of Vaseline or grease).



CAUTION

Please avoid squeezing the cable insulation or the end splice. Improper connection may damage the equipment!

4.3 Installing the communication equipment

The communication interfaces are located above the AC terminals.

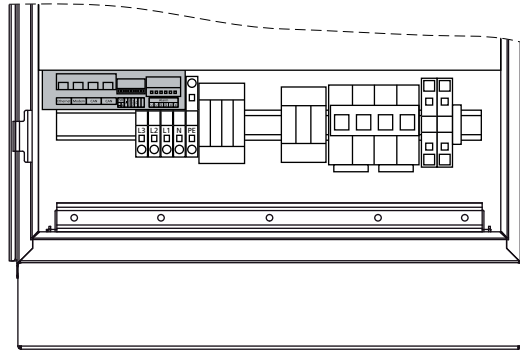

Diagram: IP 42, IP 54 variants

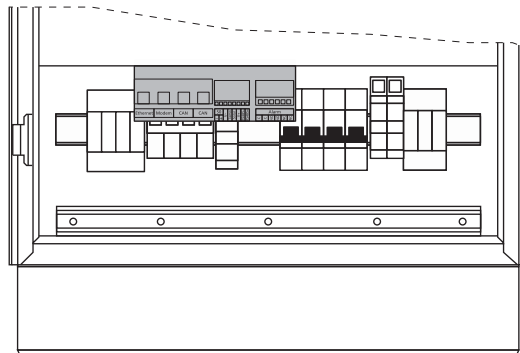
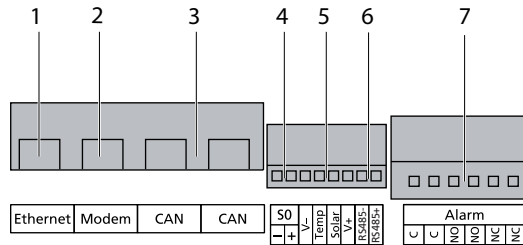

Diagram: IP 55/Outdoor variant

Interface overview



- 1 Ethernet connection
 - 2 Modem connection
 - 3 CAN bus
 - 4 S0 interface (pulse output, e.g. for large display)
 - 5 Terminal for temperature and irradiance sensor
 - 6 RS485 for external data logger
 - 7 Connection for alarm relay
- All screw connections should be tightened with a max. of 0.5 Nm.

Pin assignment

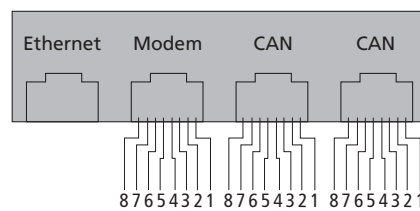

The connectors for the CAN interfaces and for the modem interface have the following pin assignment:

CAN and modem

Pin	CAN		Modem	
	Description	Meaning	Description	Meaning
1	N.C.		>1	TXh
2	CAN_GND	0 V / GND	>2	TX1
3	CAN_H	Bus line (dominant high)	<3	RXh
4	CAN_L_T	Termination	-4	VCC
5	CAN_H_T	Termination	-5	GND
6	CANL	Bus line (dominant low)	<6	RXl
7	CAN_SHLD	optional CAN shield	<7	R1h
8	N.C.		<8	R1l

Networking of Solar Inverter via CAN bus

The Solar Inverter from the NT (900 V), AT and PT series can be networked via the CAN bus interface. Use the included Ethernet cable to network the Solar Inverter with each other. Connect a terminating resistor at the first and last Solar Inverter in the series. The pluggable terminating resistors are contained in the delivery scope.

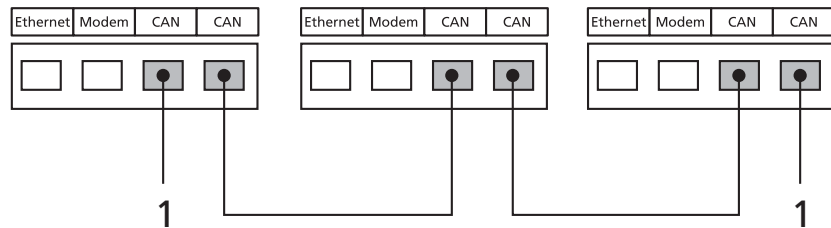

1 Terminating resistor connector



NOTE

Solar Inverter from the PT series are provided with a default setting of 125 kbit/s as standard. In contrast, Solar Inverter in the AT and NT series have a default setting of 500 kbit/s.

When networking units from different series, the bit rate must be configured identically in all units. This adjustment can be made either on the display of the Solar Inverter or in the Sunways browser.

Bit rate adjustment via the display menu: Settings – Network – CAN bus – Baud rate

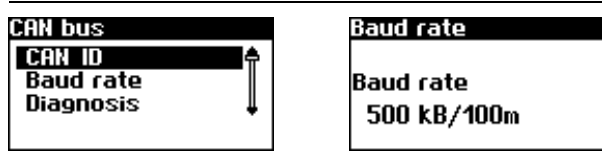

Up to 99 NT, PT and AT series units can be networked via a CAN bus. The following table shows the recommended cable cross-sections depending on bus length and number of nodes:

Bus length/ Number of nodes	Bit rate	32	64	99
100 m	500 kbit	0.25 mm ² or AWG 24	0.25 mm ² or AWG 24	0.25 mm ² or AWG 24
250 m	250 kbit	0.34 mm ² or AWG 22	0.5 mm ² or AWG 20	0.5 mm ² or AWG 20
500 m	125 kbit	0.75 mm ² or AWG 18	0.75 mm ² or AWG 18	1.0 mm ² or AWG 16

If the values in the table cannot be maintained, the signal must be strengthened with the installation of a CAN bridge, with which the length of the CAN bus can be extended up to 500 m. Bus length, number of nodes and the cable cross-section thus influence the way in which a CAN bridge is used.

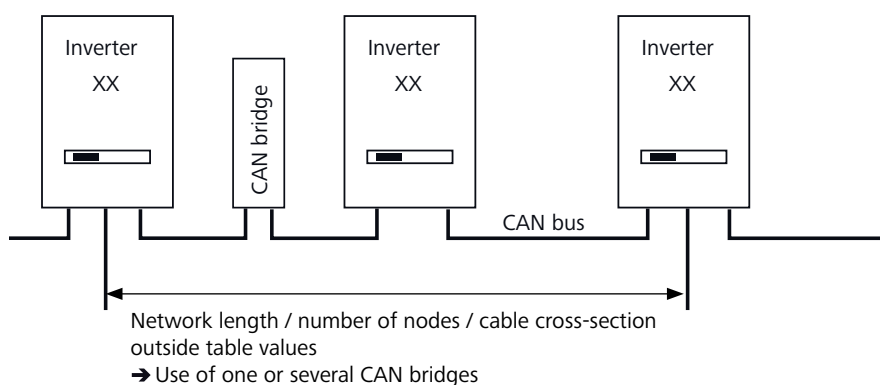

You can purchase the CAN bridge from Sunways - please contact the Technical Hotline.

The CAN bridge divides the bus into two physically independent segments. This maximum cable length of each segment is determined by the bit rate set. Therefore with a bit rate of 125 kbit/s, it is possible to have two segments with a maximum length of 500 m respectively. The total cable length can thus stretch up to 1 km in ideal cases.

To do this, if a system has a unit from the PT series, then the CAN bridge can be directly integrated into the PT Solar Inverter over which a 24 V DC power supply unit can be supplied with electricity. If a system has single-phase units of the Sunways, the CAN bridge can be integrated into the AC power distribution. In this instance, an external 24 V DC supply is necessary (power consumption 1.5 W).

S0 interface

The S0 pulse output enables, for example, the connection of a large display (Sunways display) for displaying the momentary output, the energy yields and the CO₂ reduction.

You can use the S0 interface on the master if you want to transmit the entire line yields as a sum to a large display.

Interfaces	
Irrad.	none
Temp.:	none
S0 rate/kWh:	100
S0 output:	On

The S0 interface is adjusted via the display on the inverter. Open the menu "Settings - Networking - Interfaces".

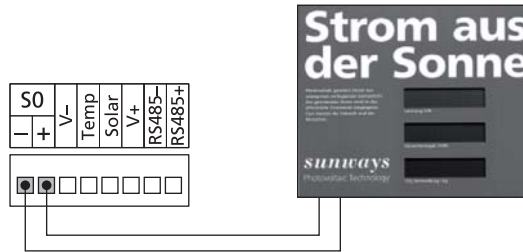

NOTE

- Please note that the maximum pulse rate may not be greater than 15 pulses/sec. Calculate the pulse rate depending on the size of the solar system using the following formula:

$$\text{Pulse rate [pulses/kWh]} = 50,000 / \text{system size [kWp]}$$

- The pulse rate must be set on your Solar Inverter and on the large display.

Temperature and irradiance sensor

The optional addition of an irradiance sensor (model Si-01TC-K from Ingenieurbüro Mencke & Tegtmeyer) with an integrated PT-100 temperature sensor for temperature measurement enables the acquisition of irradiation data and the corresponding module temperature and storage in the internal data memory as a 5-minute mean value. This additional measuring unit helps analyse the system output. Based on the values, any errors on the PV generator, e.g. shading or failure of solar cells, can be detected.

The sensor is activated via the display. In the menu Settings - Network - Interfaces, you can select the sensor type in the Irrad. and Temp. field.

Interfaces	
Irrad.	Si-01TC-T
Temp.:	none
S0 rate/kWh:	100
S0 output:	On

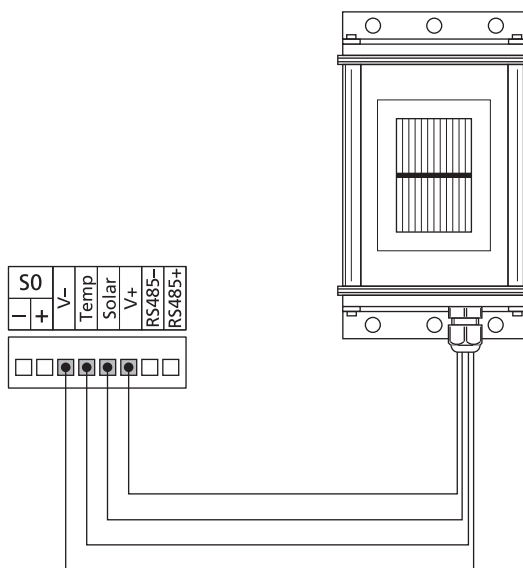

Assignment of sensor connection

Pin assignment Plug sensor	Sensor connection designation	Connection designation Solar Inverter
Pin 1	Positive-signal temperature	Temp
Pin 2	Positive signal Irradiance	Solar
Pin 3	Reference earth	V-
Pin 4	Positive connection +5 V supply	V+

Connecting the alarm relay

The Solar Inverter is equipped with a potential-free alarm relay as standard. The relay can be designed as a make-contact element or as a break-contact element and is actuated for all malfunctions signalled by the device. This ensures fast, reliable indication of a possible fault in the PV system on site. For PV systems with several units, the individual relays can be switched in parallel and connected via a common indicator lamp.

The master also signals faults from other units in the CAN network via the alarm relay. It is therefore sufficient for simple alerting to connect the alarm relay of the master.

**CAUTION**

The alarm relay is designed for 230 V / 2 A. Higher outputs/voltages can result in the relay being destroyed. The connected signalling unit must be fused separately. The terminals are intended for a cable cross-section of 0.2 mm² to 1.5 mm². When dimensioning the cross-section, also take the current consumption of the connected signalling unit into account.

Wiring diagram for a single unit

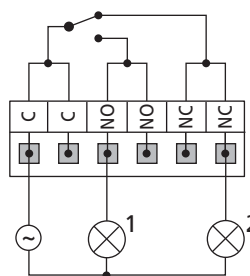

Wiring diagram for several units

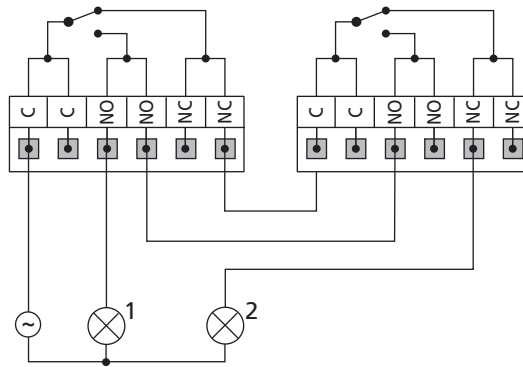

1 Indicator lamp, red

2 Indicator lamp, green



NOTE

The Solar Inverter is supplied by the L1 mains phase. If L1 fails, the alarm relay cannot respond, despite the fact that there is a fault.

5 Commissioning

5.1 Connecting and disconnecting the unit



CAUTION

- Ensure proper mechanical and electrical installation before commissioning the unit.
- Check the cables to ensure that they are in sound condition.
- Always disconnect the mains connection first by switching off the corresponding mains fuse and before disconnecting the solar generator side by opening the DC load break switch.



NOTE

The Solar Inverter is supplied from the mains. The Solar Inverter switches on automatically when sufficient solar generator output is available. Corresponding switch-on and switch-off thresholds have been defined for this purpose.

Connecting

1. Establish the grid connection via the external circuit breaker.
2. Switch on the solar generator voltage by closing the DC load break switch (switching position 1). The Solar Inverter starts operating when the input voltage level is adequate.

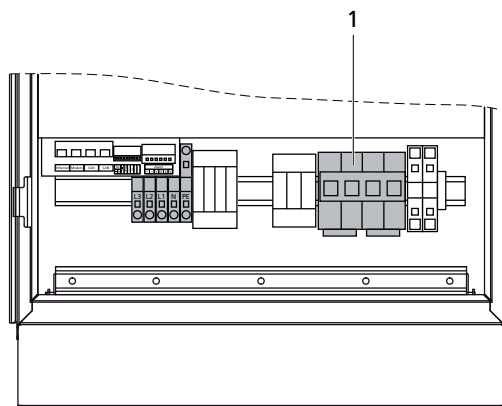

Diagram: IP 42, IP 54 variants

1 DC load break switch

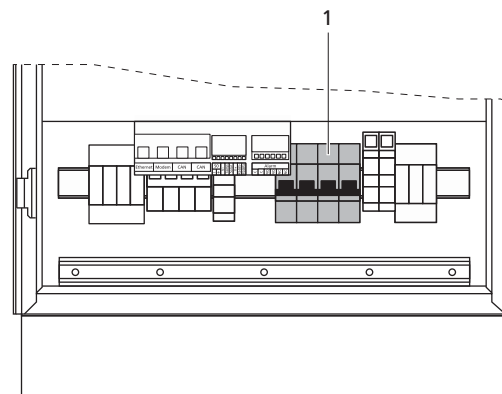

Diagram: IP 55/Outdoor variant

1 DC load break switch

The operating LED lights up in accordance with the operating state.

The commissioning menu opens when the unit is connected for the first time.

Switching off

1. Open the grid connection by switching off the circuit breaker.
2. Disconnect the solar generator side by opening the DC load break switch (switch position 0).

5.2 Commissioning

The commissioning menu comes up automatically when the unit is connected for the first time. It helps you make the standard settings.



NOTE

For a better understanding of keyboard operation, please also see the chapter Operation.

The procedure for commissioning the system as a

- single unit
- and as a master and slaves with several networked units

is described in detail below.

Please note:



NOTE

Once the system has been commissioned, the country can no longer be changed via the menu. To change the country retrospectively, please contact the Technical Hotline on Tel +49 (0)7531 99677 77-577.

Commissioning single unit

System with one inverter

Single device

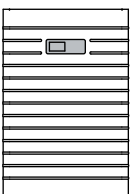

1. During initial start-up the following appears on the display:
Begin commissioning with  .

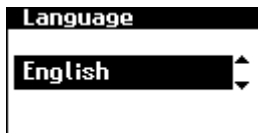

2. To do this, select the language in selection menu with / . Confirm the selected language with .



3. In the selection menu, switch to the editing mode with , set the country of use / and select with .



4. If the selected country of use is correct, select with "Yes" and confirm with .

Your unit is now set up for use on a low voltage grid. The relevant standards apply!



NOTE

The Solar Inverter only starts feeding current into the grid once the country has been selected. When installed in Germany, the unit feeds according to the Low Voltage Directive. The configuration based on the Medium Voltage Directive can be found in a separate document.



5. Select "Single unit" in the selection menu with / . Confirm with .

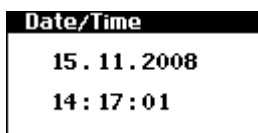

6. Set the date and time.
Select date with . Change the selected number with / and jump to the next number with / .
- Confirm the date with and set the time accordingly.
Confirm the time with .



NOTE

Please note that time settings should only be made with caution, as they directly affect data logging. For example, if you set the time back by 1 hour, then the existing data will be overwritten. Check the time during the maintenance intervals regularly for proper functioning and adjust the time at least 1x year if necessary.



7. Setting a password. Select the password with . The default password is: ***** (8 asterisks)
A new password can be set with / / / as an option.
Confirm the password with .



NOTE

Please note:

Only digits between 0 – 9 and letters between a – z and A – Z are permitted. The password always has 8 characters. If the password you entered has less than 8 characters, the remaining characters are filled with "*".

Example:

Your password is "Solar". This password has 5 characters. The system automatically appends three "*", so that the password becomes "Solar***".



8. Completion of commissioning

Confirm overview with **ok**.

Commissioning several networked units

System with several units

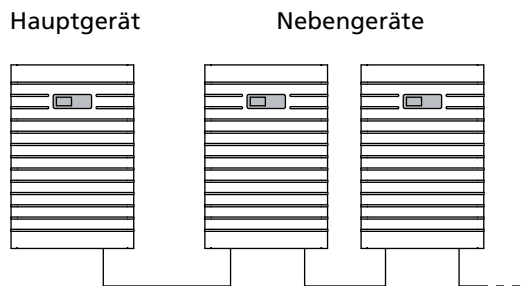

Before commissioning, all units must be interconnected via the CAN bus interface. See the chapter on networking Solar Inverter via CAN bus.

Switch on all units following installation. Start commissioning with the unit selected as the master.

Commissioning master

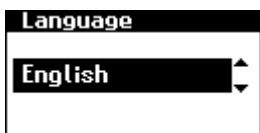

1. During initial start-up the following appears on the display: Begin commissioning with **ok**.
2. To do this, select the language in selection menu with **▲** / **▼**. Confirm the selected language with **ok**.
3. In the selection menu, switch to the editing mode with **ok**, set the country of use **▲** / **▼** and select with **ok**.



4. If the selected country of use is correct, select with "Yes" and confirm with .

Your unit is now set up for use on a low voltage grid. The relevant standards apply!

**NOTE**

The Solar Inverter only starts feeding current into the grid once the country has been selected.



5. Select "Master" entry with / .

Confirm with .

**NOTE**

The other units in the CAN network are automatically configured as slaves.

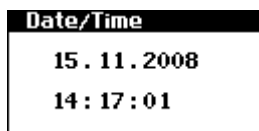

6. Set the date and time centrally for all connected units.

Select date with . Change the selected number with / and jump to the next number with / .

Confirm the date with and set the time accordingly.

Confirm the time with .

**NOTE**

Please note that time settings should only be made with caution, as they directly affect data logging. For example, if you set the time back by 1 hour, then the existing data will be overwritten.

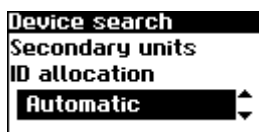

7. Automatic or manual device search

The IDs for the slaves can be allocated automatically or manually.



8. CAN network list is set up.

If the search is set to manual, the IDs must be confirmed at each slave before commissioning of the master is continued.

Confirm with .

**NOTE**

Depending on the side of the network, it may take a moment until the master has found all slaves and added them to the list.



9. Set password centrally for all connected units. Select the password with .

The default password is:

***** (8 asterisks)

A new password can be set with / / / as an option.

Confirm the password with .



NOTE

Please note:

Only digits between 0 – 9 and letters between a – z and A – Z are permitted. The password always has 8 characters. If the password you entered has less than 8 characters, the remaining characters are filled with "*" .

Example:

Your password is "Solar" . This password has 5 characters. The system automatically appends three "*" , so that the password becomes "Solar***" .



10. Completion of commissioning

Confirm overview with .

Commissioning slaves

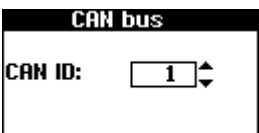

After a master has been defined, the display for requesting the CAN-ID is automatically shown on the display on each slave in a manual device search.

1. Request CAN ID (this step is only necessary for manual device searches)

Request the next higher free ID from the master with or the next lower free ID with .

The master assigns a free ID to the slave. Confirm the ID within 5 seconds with .

Request further IDs with / .

Confirm the CAN ID with within 5 seconds.

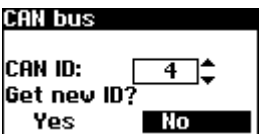

NOTE

The data for the slaves can be assigned in the Sunways browser and in the menu of the master based on the IDs.

The CAN-ID 1 is automatically assigned to the master. This means the slaves can be assigned IDs from 2 to 99.

Commissioning cannot be continued until after an ID has been requested from the master.

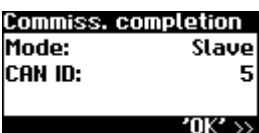

2. Completion of commissioning

Confirm overview with .

3. Commissioning of all other slaves as described above

Later commissioning

If you add new units or replace existing ones in your solar system, then you can display the unit list in the display on the master under Settings - Network - CAN bus. The new unit can then be put into operation in accordance with the description for commissioning slaves.

**NOTE****Configuration of grid security management**

The inverter has grid management functions in accordance with the following guidelines:

- Technical directive "Power generating facilities using medium-voltage grids" from the German Energy and Water Association (BDEW).
- VDE code of practice "Power generation facilities using low-voltage grids"

These functions can be configured via the Sunways browser on your computer. The inverter must be connected to the network in order to configure these functions. A device-specific password is required for access to the grid security management configuration pages. This can be obtained on request from the technical hotline. To do this you must quote the serial number of the inverter which has been configured as the master.

1. Remotely controlled output reduction
 2. Provision of reactive power in normal operation
 3. Grid support mode: Limitation of active power at overfrequency
 4. Grid support mode: Fault Ride Through (FRT) when mains faults occur – supply of reactive current (short circuit current) to actively support voltage when there is a voltage drop at the feed point.
-

6 Operation

6.1 General information

Operating elements

Operating field

The unit is operated via the control panel at the front.

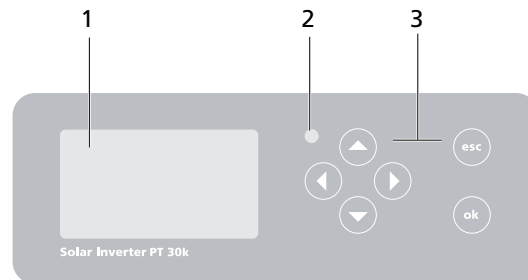

1 LCD display (lighted)

3 Keyboard

2 Operating LED

LCD display

A graphics-capable, monochrome dot matrix display is integrated in the operating field. In standard mode the momentary output, daily yield and status are displayed. The bar graph shows the energy feed-in of the current day.

Press any key to activate the display lighting.

If no key is pressed for approx. 1 minute, the display lighting goes out.









NOTE

Important!

The LCD display is not a calibrated measuring device. A deviation of several percent is inherent in the system. Exact accounting of the data with the power supply company requires a calibrated meter.

Keyboard

The keyboard can be used to navigate in the menu, edit text fields, select entries from lists and enter numbers consecutively and digit by digit. User entries can only be made if the value to be changed is selected. The cursor changes visibly in the editing mode and indicates the digit to be changed.

 key	Scroll up
 key	Scroll down
 key	Select menu item
 key	Back one menu level
 key	Select a menu item and confirm your entry
 key	Quit

Operating LED

The combined red/green LED indicates the status of the PT 30k to PT 33k:

- LED off

Solar Inverter is not active (night mode)

- LED green, continuously lit

Solar Inverter is active and feeds into the grid (MPP mode)

- LED green, flashing

Solar Inverter is active and feeds into the grid, although with current, output or temperature limitation

- LED red, continuously lit
a fault has occurred (malfunction)

- LED red, flashing
a warning has been output

Standard screen (single unit)

The standard screen is always shown when no keyboard entry is made for more than 1 minute. It can also be called up manually with the menu item "Solar Inverter – Instantaneous Values".

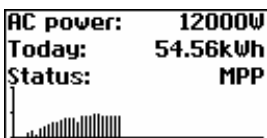

The standard screen shows the most important data at a glance. In the first line you see the momentary feed-in power. In the second line the fed-in energy for the day is shown.

The status signals the unit status with the following messages:

MPP	Feeding in MPP mode
AC curr. lim.	Feeding with AC current limitation
DC curr. lim.	Feeding with DC current limitation
Temp. lim.	Feeding with temperature limitation
Output lim.	Feeding with output limitation
Feed.	Feeding
Warning	A warning has been output
Error	An error has occurred
Night	Night mode
Start	Device initialisation phase
COM-Upd.	The communication software is being updated
DSP-Upd.	The control software is being updated

The graphic in the lower section of the screen shows the energy fed in for the day as a bar graph. The current period is shown as a flashing bar, as it is still increasing.

Standard screen (system)

You can view the system data for a CAN-networked system with this screen.



Next to the total current system output, you also see the energy yield of your solar system and any status messages of all connected units. These are provided with the inverter number. An "M" means that the error has occurred on the master.

**NOTE**

- The various functions are accessed via the menu. The main menu is opened from the standard screen by pressing **esc** twice.
- You can return to the standard screen at any time by pressing and holding the **esc** key.
- If a status message is shown you can open the error list directly with **ok**.
- You can access other instantaneous values from the standard screen with **↑** and **↓**.

Access rights

Operation of the unit is divided into various password-protected sections.

The password has 8 places.

The password can be entered in the menu item "Settings – Login".

**NOTE**

If no entry is made with the keyboard after entering the password, it is necessary to re-enter the password after approximately 5 minutes.

Customer area

The customer password must be entered to access this area. All settings required for installation and commissioning of the unit are available.

**NOTE**

- The password for the customer area is:

- The password is preset and is directly confirmed with **ok**.
- As an option, you can assign a personal password in the Commissioning menu. Only digits between 0 – 9 and letters between a – z and A – Z are permitted.
- The password always has 8 characters. If the password you entered has less than 8 characters, the remaining characters are filled with "*".
- Example:
Your password is "Solar". This password has 5 characters. The system automatically appends three "*", so that the password becomes "Solar***".

Installer area

In this section, the installer can make special settings on the Solar Inverter which are only possible after consulting the Technical Hotline. Request a device-specific password from the Technical Hotline.

Technical Hotline +49 (0) 7531 996 77-577

Menu structure



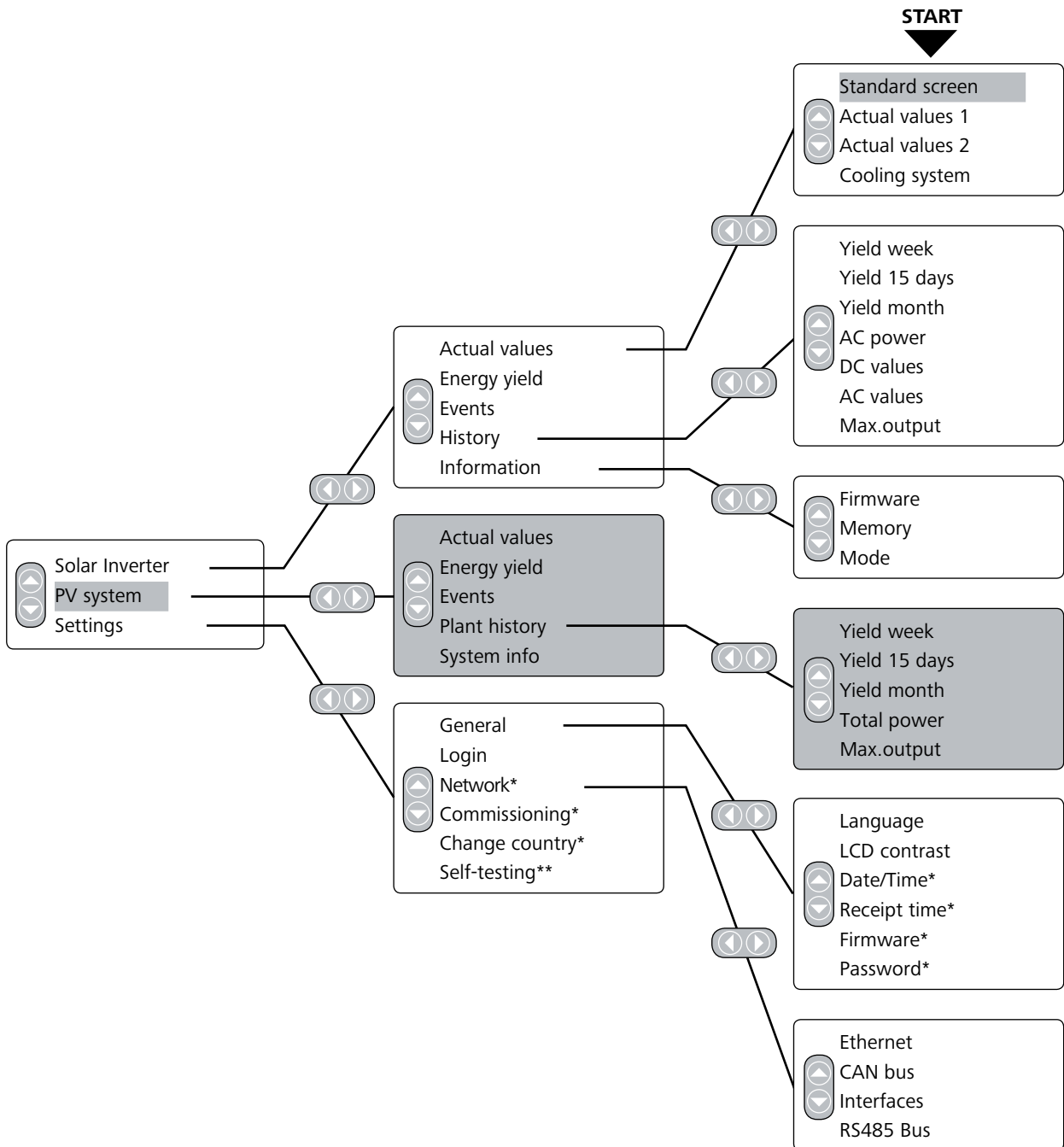







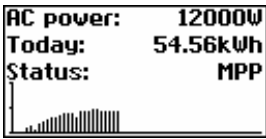

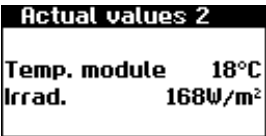
The menu provides access to all screens on the Solar Inverter. The menu is opened by pressing the left arrow key from the standard screen.

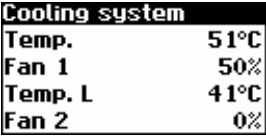

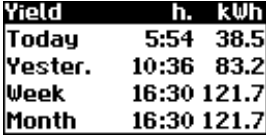
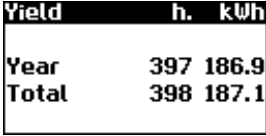

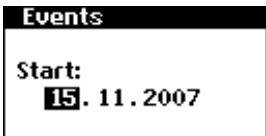
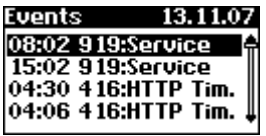

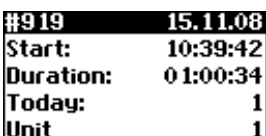



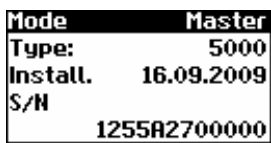

NOTE





- The areas highlighted in grey are only available in the master
- *) after entering the customer password. Standard password: ***** (= 8 asterisks)
- **) this is only shown if the configured country of installation is Italy

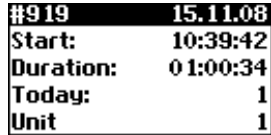

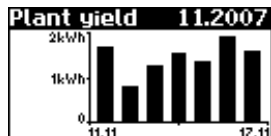
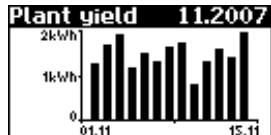

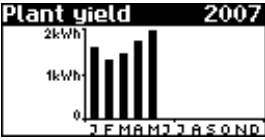
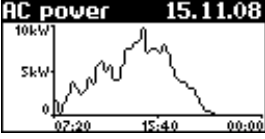
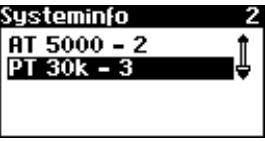
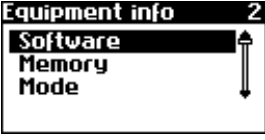
Overview of screen displays

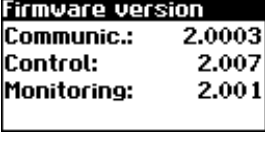
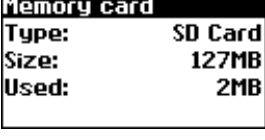
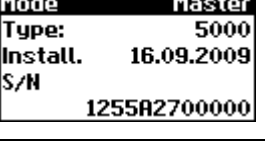
Display	Description	Calling Menu															
Instantaneous Values – Unit																	
	Current feed-in power, daily energy MPP: Feeding in MPP mode	The screen appears automatically if no key is pressed for several minutes. Solar Inverter – Instantaneous values															
<table border="1" data-bbox="193 510 459 645"> <thead> <tr> <th></th> <th>U[V]</th> <th>I[A]</th> </tr> </thead> <tbody> <tr> <td>DC</td> <td>760</td> <td>17.7</td> </tr> <tr> <td>L1</td> <td>228</td> <td>19.0</td> </tr> <tr> <td>L2</td> <td>226</td> <td>19.2</td> </tr> <tr> <td>L3</td> <td>226</td> <td>18.5</td> </tr> </tbody> </table>		U[V]	I[A]	DC	760	17.7	L1	228	19.0	L2	226	19.2	L3	226	18.5	Display of voltages and currents from solar generator and grid	Solar Inverter – Instantaneous values – 
	U[V]	I[A]															
DC	760	17.7															
L1	228	19.0															
L2	226	19.2															
L3	226	18.5															
	Module temperature and irradiance values (if sensor is connected)	Solar Inverter – Instantaneous values – 															
	Display of heat sink and choke temperature and load of the two fans	Solar Inverter – Instantaneous values –  – 															
	AC yields and operating hours from today, yesterday, week and month	Solar Inverter – Energy yield															
	AC yields and operating hours from year and total value	Solar Inverter – Energy yield – 															
Events – Unit																	
	Select starting data for event display	Solar Inverter – Events															
	Display event list The event list shows the last 200 system messages from the start date. The heading always refers to the selected event. The CAN comm. message displayed here must not necessarily be from 07/05/2006, it may be older.	Solar Inverter – Events – 															
	Display event details (error number, data, starting time, duration and number of occurrences per day)	Solar Inverter – Events –  – 															

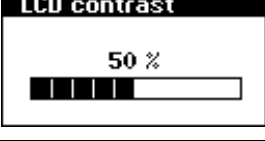
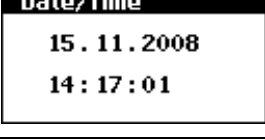
Display	Description	Calling Menu
History – Unit		
	Daily yield for 1 week	Solar Inverter – History – Yield for week
	Daily yields for 15 days	Solar Inverter – History – Yield for 15 days
	Monthly yields	Solar Inverter – History – Yield for month
	AC output (5-min. values)	Solar Inverter – History – AC output
	DC voltage (5-min. values)	Solar Inverter – History – DC values
	DC current (5-min. values)	Solar Inverter – History – DC values– ⏴
	AC current L1 (5-min. values) AC current L2 (5-min. values) AC current L3 (5-min. values)	Solar Inverter – History – AC values Switching between currents L1, L2 and L3 with ok
	AC voltage L1 (5-min. values) AC voltage L2 (5-min. values) AC voltage L3 (5-min. values)	Solar Inverter – History – AC values Switching between voltages L1, L2 and L3 with ok
Information – Unit		
	Firmware	Solar Inverter – Information – Firmwa- re
	Memory card	Solar Inverter – Information – Memory

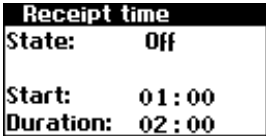
Display	Description	Calling Menu
	Device mode	Solar Inverter – Information – Mode
Instantaneous values – Solar system (display only master)		
	Current system feed-in power, daily energy yield and system status	The screen appears on the master automatically when you do not make any entries with the keyboard for several minutes. Solar system – Instantaneous values
Yields – Solar system (display only master)		
	AC system yields and operating hours from today, yesterday, week and month	Solar system – Energy yield
	AC system yields and operating hours for year and total value	Solar system – Energy yield – 
Events – Solar system (display only master)		
	Select starting data for system event display	Solar system – Events
	Display event list for entire system The event list shows the last 200 system messages from the start date. The heading always refers to the selected event. The CAN comm. message displayed here must not necessarily be from 10/05/2007, it may be older.	Solar system – Events – 
	Display event details (error number, data, starting time, duration and number of occurrences per day)	Solar system – Events –  – 
History – Solar system (display only master)		
	Solar system daily yield for 1 week	Solar system – System history – Yield for week
	Solar system daily yield for 15 days	Solar system – System history – Yield for 15 days

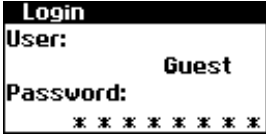
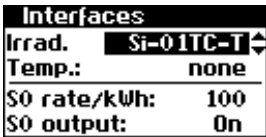
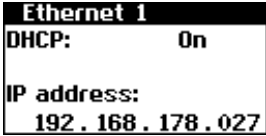
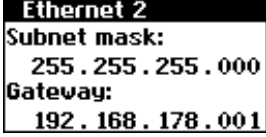
Display	Description	Calling Menu
	Solar system monthly yields	Solar system – System history – Yield for month
	Solar system AC output (5-min. values)	Solar system – System history – AC output
System info – Solar system (display only master)		
	Unit list for selecting a unit	Solar system – System info
	Selection of information	Solar system – System info – 
	Firmware	Solar system – System info – Firmware
	Memory card	Solar system – System info – Memory
	Device mode	Solar system – System info – Mode
Settings – General		
	Display language	Settings – General – Language
	LCD contrast	Settings – General – LCD contrast
	Set date/time (only possible with customer password)	Settings – General – Date/Time

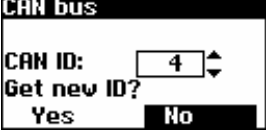
Display	Description	Calling Menu
	Set receiving time (starting time and duration in which the unit can also be addressed in the night mode via the network). (only possible with customer password)	Settings – General – Receiving time
	Changing the customer password (only possible with customer password)	Settings – General – Password
Settings – Login		
	Password entry to access advanced settings (necessary for commissioning)	Settings – Login
Settings – Network (only possible with customer password)		
	Setting of the irradiance and temperature sensor and configuration of the S0 pulse output	Settings – Network – Interfaces
	Network settings (Screen 1) Activate DHCP for automatic IP address setting or enter IP address manually	Settings – Network – Ethernet
	Network settings (Screen 2)	Settings – Network – Ethernet – 
	Have CAN bus ID assigned by the master	Settings – Network – CAN bus

Error messages

The Solar Inverter indicates faults on the LCD display and saves them in the internal error memory.

The fault display consists of a number and a short description. Based on the first number, you can quickly recognise which area the fault has occurred in:

- 1: Solar generator fault
- 2: AC grid fault
- 3: Inverter fault
- 4: Interface/communication fault

9: Service error

If an error is shown in the standard display, then you can look up the exact error message in the menu under "Solar Inverter – Events".



NOTE

- A restart may be attempted in the event of an error message.
 - Please note the serial number of the unit and the error number before contacting the Technical Hotline.
 - The Technical Hotline can be contacted on +49 (0) 7531 996 77-577 between 7.30 am and 6 pm CET during weekdays.
-

Display message	Description	Cause and possible remedies
Solar generator fault		
101:U-DC max.	Your PT series Solar Inverter is approved for a maximum open-circuit voltage of the solar generator of 1000 V. All DC input components are adequately dimensioned with a safety margin. The Solar Inverter stops feeding if the threshold is exceeded.	The maximum DC voltage was exceeded. <ul style="list-style-type: none"> Check the dimensioning of your PV generator. Too many modules are connected in series. <ul style="list-style-type: none"> Reduce the number of modules and re-commission the system.
102:Insulation	Before each connection, your Solar Inverter checks the PV system for a possible earth fault or insulation faults. If this kind of error is detected, no feed in takes place. The mode of operation is compliant with DIN V VDE 0126-1-1.	The Solar Inverter has detected an insulation fault in the PV system during startup. <ul style="list-style-type: none"> Check your PV system for possible insulation faults (damaged DC cables etc.). The measured insulation resistance must be at least 1000 kΩ.
103:AFI>30 mA 104:AFI>0.3 A	Your Solar Inverter is equipped with an AC/DC sensitive AFI according to DIN VDE 0126-1-1. The monitoring unit has detected a sudden relative residual current increase of >30 mA or an absolute residual current of >300 mA.	A sudden residual current increase has occurred during the unit operation. <ul style="list-style-type: none"> Check your PV system for possible insulation faults.
105:I-DC max.	Your PT series Solar Inverter is approved for a maximum DC current of 75 A. If the threshold is exceeded, the Solar Inverter limits the DC current by moving the operating point.	The maximum solar generator current permitted for the inverter was reached. <ul style="list-style-type: none"> Check that the module interconnection generates an input voltage of less than 420 VDC at full load and rewire the modules according to the min. DC input voltage of 420 VDC.
AC grid fault		
201:UAC1<Min 202:UAC2<Min 203:UAC3<Min	AC undervoltage Your Solar Inverter continuously monitors the voltage levels for feed phases L1, L2 and L3. If the voltage falls below the minimum permissible limit, the Solar Inverter stops feeding and does not start up again until the voltage value exceeds the minimum limit value.	<ul style="list-style-type: none"> Ask your power supply company (PSC) about grid stability and design. Ensure that the cross-sections of the feed lines are adequate, depending on country-specific standards and guidelines.
204:UAC1>Max 205:UAC2>Max 206:UAC3>Max	AC overvoltage Your Solar Inverter continuously monitors the voltage levels for feed phases L1, L2 and L3. If the maximum permissible limit is exceeded, the Solar Inverter stops feeding and does not start up again until the voltage value drops below the maximum permissible limit.	<ul style="list-style-type: none"> Ask your power supply company (PSC) about grid stability and design. Ensure that the cross-sections of the feed lines are adequate, depending on country-specific standards and guidelines.

Display message	Description	Cause and possible remedies
<p>207:UAC1>10 % 208:UAC2>10% 209:UAC3>10%</p>	<p>AC overvoltage for 10 minutes Your Solar Inverter continuously monitors the voltage levels for feed phases L1, L2 and L3. If the permitted limit value is exceeded for 10 minutes on average, the Solar Inverter stops feeding and restarts after approx. 1 minute.</p>	<ul style="list-style-type: none"> • Ask your power supply company (PSC) about grid stability and design. • Ensure that the cross-sections of the feed lines are adequate, depending on country-specific standards and guidelines.
<p>210:UAC1>10 % 211:UAC2>10% 212:UAC3>10% (Warnings)</p>	<p>AC overvoltage warning This warning appears if a voltage which is too high is measured on a mains phase. The Solar Inverter switches off if the limit is exceeded for more than 10 minutes.</p>	<ul style="list-style-type: none"> • Ask your power supply company (PSC) about grid stability and design. • Ensure that the cross-sections of the feed lines are adequate, depending on country-specific standards and guidelines
<p>213:Frq1<Min 214:Frq2<Min 215:Frq3<Min 216:Frq1>Max 217:Frq2>Max 218:Frq3>Max</p>	<p>Grid frequency The Solar Inverter continuously monitors the grid frequency for feed phases L1, L2 and L3. If the value for a phase is outside the permitted range, the Solar Inverter stops feeding and does not start up again until the value is within the tolerance range. Restart time: approx. 45 s</p>	<ul style="list-style-type: none"> • Ask your power supply company (PSC) about grid stability and configuration
<p>219:IDC1>Max 220:IDC2>Max 221:IDC3>Max</p>	<p>DC share in AC current Your Solar Inverter continually monitors the quality of current that is fed in. If the maximum DC share in the current fed in is exceeded, the Solar Inverter stops feeding.</p>	<ul style="list-style-type: none"> • Restart the Solar Inverter. If the error still occurs, please contact the technical hotline. The phone number is provided on the back of the manual.
<p>222:Uexternal</p>	<p>External conductor voltage outside tolerance range. Invalid phase shift between L1, L2 and L3.</p>	<ul style="list-style-type: none"> • Ask your power supply company (PSC) about grid stability and design. • Ensure that the cross-sections of the feed lines are adequate, depending on country-specific standards and guidelines.
<p>223:Surgef.</p>	<p>Your Solar Inverter continuously monitors the quality of the AC grid. During high voltage peaks on the phase feeding in, the Solar Inverter stops feeding and attempts a restart.</p>	<p>The Solar Inverter has detected a high voltage peak on a phase feeding in.</p> <ul style="list-style-type: none"> • After successful troubleshooting, the Solar Inverter restarts automatically. • A monitoring phase and a neutral conductor were interchanged during connection of the AC side
<p>Inverter fault</p>		

Display message	Description	Cause and possible remedies
301:HS temp. 302:Choke temp. 303:PCB temp. (Warnings)	<p>Your Solar Inverter is designed for an ambient temperature of up to +40 °C at full feed-in power. These warnings refer to violations of the temperature threshold for the heat sink (HS), choke or PCB.</p> <p>The feed-in power is reduced linearly in order to prevent further temperature increase.</p>	<p>The maximum permissible ambient temperature has been exceeded.</p> <ul style="list-style-type: none"> The installation location may be unsuitable. Please try and find an alternative installation location or improve the ventilation of the installation space. <p>The air circulation requirement was not taken into account during installation.</p> <ul style="list-style-type: none"> Clean the Solar Inverter if dirt obstructs cooling. Follow the installation instructions in the manual.
304:Mains rel.	<p>The PT series Solar Inverter checks the operation of the mains relay whenever it is switched on. An error was detected during this check.</p>	<ul style="list-style-type: none"> Restart the Solar Inverter. <p>If the error still occurs, please contact the technical hotline. The phone number is provided on the back of the manual.</p>
305:HS overtemp. 306:Choke overtemp. 307:PCB overtemp.	<p>These error messages refer to violations of the temperature threshold for the heat sink (HS), choke or PCB. Feed is stopped. The Solar Inverter automatically switches back on again once the temperature at the corresponding measuring point has dropped again.</p>	<p>The maximum permissible ambient temperature has been exceeded.</p> <ul style="list-style-type: none"> The installation location may be unsuitable. Please try and find an alternative installation location or improve the ventilation of the installation space. <p>The air circulation requirement was not taken into account during installation.</p> <ul style="list-style-type: none"> Clean the Solar Inverter if dirt obstructs cooling. Follow the installation instructions in the manual.
Interface/communication fault		
401:SD Card	The Solar Inverter cannot find an SD card.	<ul style="list-style-type: none"> Restart the Solar Inverter. <p>If the error still occurs, please contact the technical hotline. The phone number is provided on the back of the manual.</p>
402:SD Card	The SD card is write-protected.	<ul style="list-style-type: none"> Restart the Solar Inverter. <p>If the error still occurs, please contact the Technical Hotline. The phone number is provided on the back of the manual.</p>
403:CAN User	Communication error with CAN user.	<ul style="list-style-type: none"> Check whether an error has occurred in the CAN secondary unit. Restart the secondary unit and main unit if necessary.

Display message	Description	Cause and possible remedies
404:CAN Bus	CAN bus not in operation.	<p>No communication is possible via the CAN bus.</p> <ul style="list-style-type: none"> • Check the bus cables and termination resistors. • Check whether the maximum line lengths are within the permitted limits. • Check whether bus cables were installed parallel to power cables. Disconnect bus lines and power cables if necessary.
405:CAN User	CAN user does not respond.	<ul style="list-style-type: none"> • Check whether an error has occurred in the CAN secondary unit. Restart the secondary unit and main unit if necessary.
406:Solar 407:Temp. (Warning)	No sensor found on sensor channel 1 (solar) or 2 (temperature).	<p>If a sensor is connected at Solar or Temp:</p> <ul style="list-style-type: none"> • Check the sensor connection. <p>If no sensor is connected:</p> <ul style="list-style-type: none"> • Check the sensor input configuration via the LCD display or the Sunways browser.
408:CAN comm. (Warning)	Communication malfunctions occur repeatedly on the CAN bus.	<p>A malfunction occurs in the data transmission on the CAN bus. However, a data exchange continues to be possible.</p> <ul style="list-style-type: none"> • Check whether all bus line connectors and terminating resistors are mounted properly. • Check whether bus cables were installed parallel to power cables. Disconnect bus lines and power cables if necessary.
409:CAN Cfg. (Warning)	The CAN bus is in configuration mode. No measured values are transferred.	<p>At least one unit is in the menu item "Settings – Network – CAN bus".</p> <ul style="list-style-type: none"> • Close this menu in all units.
410:SMTP Ser. (Warning)	SMTP server cannot be reached	<p>An error occurred during e-mail delivery. Re-attempting e-mail delivery.</p>
411:SMTP Soc. (Warning)	SMTP no socket available	<ul style="list-style-type: none"> • If the fault keeps recurring, check the e-mail settings via the Sunways browser
412:SMTP com (Warning)	SMTP faulty communication with server	

Display message	Description	Cause and possible remedies
413:DNS failed (Warning)	DNS has failed	Communication fault between the integrated web server and an Internet browser in conjunction with the Sunways browser.
414:HTTP Con. (Warning)	HTTP client connection has failed	These warnings are non-critical and can be ignored if they only occur occasionally.
415:HTTP Aut. (Warning)	HTTP client authorisation has failed	
416:HTTP Tim. (Warning)	HTTP client timeout	These warnings have no effect on the energy production of the inverter.
417:HTTP Soc. (Warning)	HTTP client no socket available	
418:HTTP Soc. (Warning)	HTTP client error with socket	
419:HTTP Met. (Warning)	HTTP client incorrect method	
420:HTTP Pro. (Warning)	HTTP client error with protocol	
421:HTTP Wri. (Warning)	HTTP client write error	
422:HTTP Rea. (Warning)	HTTP client read error	
423:CAN Init (Warning)	CAN initialisation error	CAN bus initialisation fault during device startup. <ul style="list-style-type: none"> Restart the Solar Inverter. If the error still occurs, please contact the Technical Hotline. The phone number is provided on the back of the manual.
424:NTP failed	Time synchronisation with the NTP server has failed.	Firewall port 123 is blocked. <ul style="list-style-type: none"> Select an alternative time server
425:Min. rest. 426:Day rest. 427:Mon. rest. 428:Year rest. 429:Tot. rest. 430:Sys. rest. 431:File rest.	If there is an error in the SD file system, the data logger files will be reset. This means that data previously present will be lost. (Warnings)	Write errors are very rare and can have various causes. No remedy on the part of the user is necessary.
432:PSC 0% 433:PSC 10 % 434:PSC 20 % 435:PSC 30 % 436:PSC 40 % 437:PSC 50 % 438:PSC 60 % 439:PSC 70 % 440:PSC 80 % 441:PSC 90 % 442:PSC 100 %	Output limitation set by PSC as a percentage value of rated capacity (warnings)	The PSC may temporarily reduce system output in accordance with guidelines.

Display message	Description	Cause and possible remedies
443:PSC M1	Mode change by PSC CosPhi = 1	The PSC may change the operating mode in accordance with guidelines.
444:PSC M2	Mode change by PSC fixed CosPhi	
445:PSC M3	Mode change by PSC fixed reactive power	
446:PSC M4	Mode change by PSC CosPhi(P)	
447:PSC M5	Mode change by PSC Q(U)	
Service fault		
9xx:Service fault 9xx: Service warning	A service error has occurred.	<ul style="list-style-type: none"> Disconnect the Solar Inverter from the grid and from the solar generator and reconnect it. <p>If the error occurs again, please contact the Technical Hotline. The phone number is provided on the back of the manual.</p>

6.2 System monitoring

General information

The basis for the system monitoring is the data logger integrated in the Solar Inverter PT series. The Solar Inverter of the PT series series offer a wide range of monitoring options for your solar system:

- The Sunways browser can display instantaneous values, stored operating data and settings.
- With active alerting, information about faults in the solar system can be sent to a selected recipient via e-mail.
- Via the Sunways portal connection the PT series Solar Inverter can send the operating data of your solar system to the Sunways portal on a daily basis without additional hardware. In this way, you can monitor your yields via the Internet from wherever you are.

Three networking options are available for access to the system monitoring function:

- Direct connection via an Ethernet cable (see section Direct Ethernet connection) or internal network (see section Connection via an existing Ethernet network)



NOTE

With a direct connection or an internal network without gateway to the Internet, the Solar Inverter is unable to send e-mails. Portal connection and active alerting is therefore not possible.

- Connection via Internet, e.g. via a DSL connection for the unit (see section Remote access via a DSL router)
- Connection via a Sunways modem (see section Connection via a Sunways modem)

Integrated data logger

The integrated data logger stores the operating data of your solar system. In addition to 5-minute mean values, energy yields are also stored as 5-minute, daily, weekly, monthly and annual values. In addition up to 200 error/warning messages can be stored. Each data record contains the data and time. The data logger

is designed as a circulating memory, i.e. the respective oldest data are overwritten with new data.

Operating data (5-min. average values)

Number	Value
2000	DC current
2000	DC voltage
2000	AC current L1
2000	AC current L2
2000	AC current L3
2000	AC voltage L1
2000	AC voltage L2
2000	AC voltage L3
2000	AC output
2000	Unit temperature
2000	Module irradiance (opt.)
2000	Module temperature (opt.)

Energy Yields

Number	Value
2000	5-minute yield
800	Daily yield
800	Weekly yield
250	Monthly yield
20	Annual yield

Status messages

Number	Value
200	Status changes

Direct Ethernet connection

The Solar Inverter are equipped with an Ethernet interface as standard for system monitoring and configuration with a PC.

Connect your PC and the Solar Inverter using the Ethernet cable provided. X-patch cables can also be used.

The PC is connected to the master as standard. Basically all Solar Inverter – including Solar Inverter configured as secondary units or single units – feature their own web server, so that a connection with any device can be established.

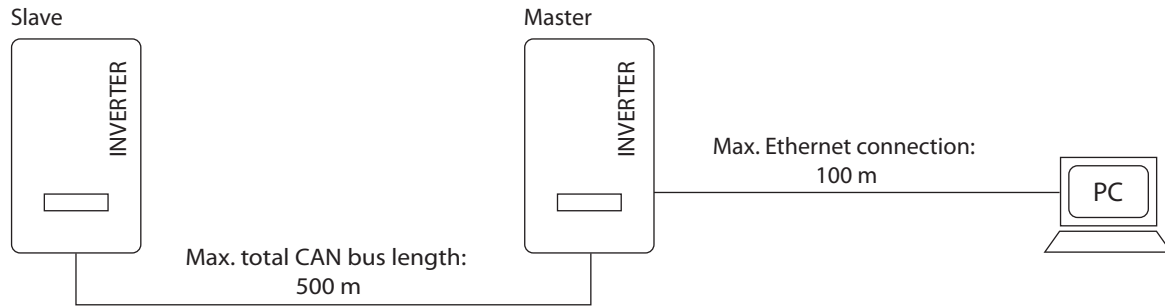

NOTE

- To always find the suitable configuration for installation and commissioning on the PC, we recommend the use of a second network card (e.g. PCI bus, PCMCIA) which you can configure to match the default setting of the PT 30k to PT 33k.
- The PC and the Solar Inverter must have matching IP addresses and net masks. The network settings can be adjusted either directly on the Solar Inverter via the LCD display or on your PC. Example: Solar Inverter with the IP: 192.168.30.50, PC with the IP: 192.168.30.51, subnet mask (PT 30k to PT 33k & PC): 255.255.255.0
- If two network cards are used, the IP addresses must be in separate subnets, e.g. 192.168.30.XXX and 192.168.40.XXX.

Network settings on the Solar Inverter



NOTE

- The Solar Inverter is supplied with the following preset IP address:
192.168.30.50
- In the default setting, the Solar Inverter does not support DHCP (Dynamic Host Configuration Protocol). Therefore, the IP address is not assigned automatically. It is possible to activate the DHCP protocol via the Settings menu.
- IP addresses may not be assigned twice within the network!

If required, you can assign your own IP address for the Solar Inverter via the Settings menu.

1. Open the menu Settings – Login.
2. Enter the default password (*****, i.e. 8 asterisks) or the password you have assigned.



NOTE

Please note:

Only digits between 0 – 9 and letters between a – z and A – Z are permitted. The password always has 8 characters. If the password you entered has less than 8 characters, the remaining characters are filled with "*" .

Example:

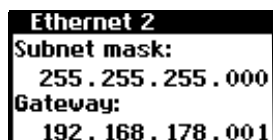
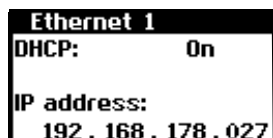

Your password is "Solar" . This password has 5 characters. The system automatically appends three "*" , so that the password becomes "Solar***" .



3. Open the menu "Settings – Network – Ethernet".
4. Enter an IP address PC matching your PC. I.e. the first three number blocks must be identical, the last number block different.

Example:

If your PC has the IP address 192.168.1.1, assign the IP address 192.168.1.2 to the Solar Inverter

5. Call up additional settings with  .
6. Enter the subnet mask **255.255.255.0** here.
7. Enter the IP address of your PC in the gateway.
8. Confirm with  .

After the connection is established, you can start the Sunways browser by entering the IP address of the solar inverter in the address line of your web browser. PT 30k to PT 33k

Network settings on PC

To enable your PC to communicate with the Solar Inverter, you must assign network settings. The procedure differs slightly depending on the operating system. A configuration example under Windows®XP is shown below.



NOTE

IP addresses may not be assigned twice within the network!

1. Select Start - Settings.
2. Select Network Connections.



Operation

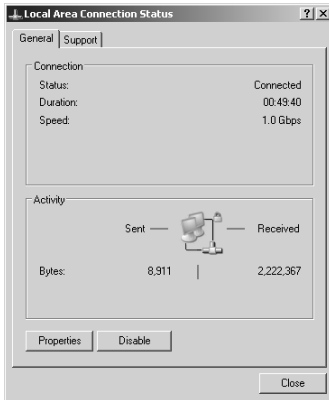

3. Double-click on the LAN connection via which you are connected to the Solar Inverter.

4. Click in the Status window on "Properties".

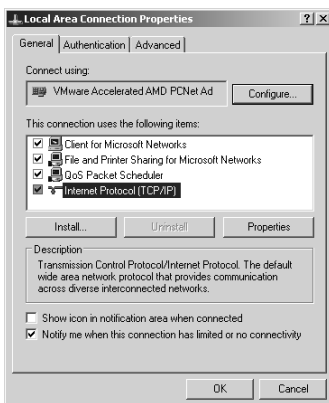

5. Mark Internet Protocol (TCP/IP) and click on "Properties" again.



6. Now assign an unused IP address **192.168.30.XXX** and enter the subnet mask **255.255.255.0**.

7. Click on OK to confirm your entries.

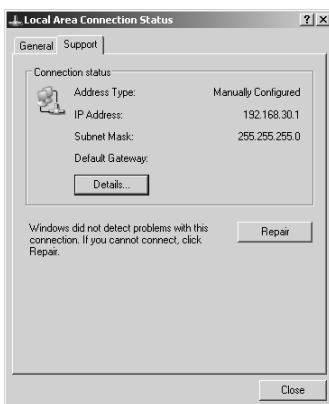

8. In the "Status" menu item, you can check the correctness of your entries and the status of your connection.

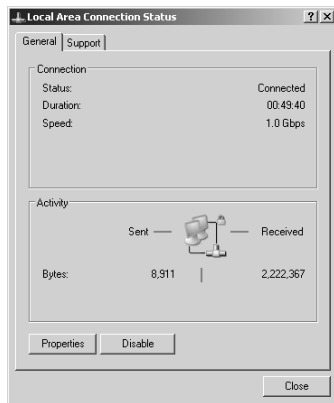

After the connection is established, you can start the Sunways browser by entering the IP address of the PT series in the address line of your web browser.

For more complex network configurations, please contact your network administrator.

Connection via an existing Ethernet network

You can integrate the PT series Solar Inverter directly in an existing home or company network as a network device.

Connect your PC and the Solar Inverter with a CAT 5 Ethernet patch cable.

The master is connected to the network as standard.

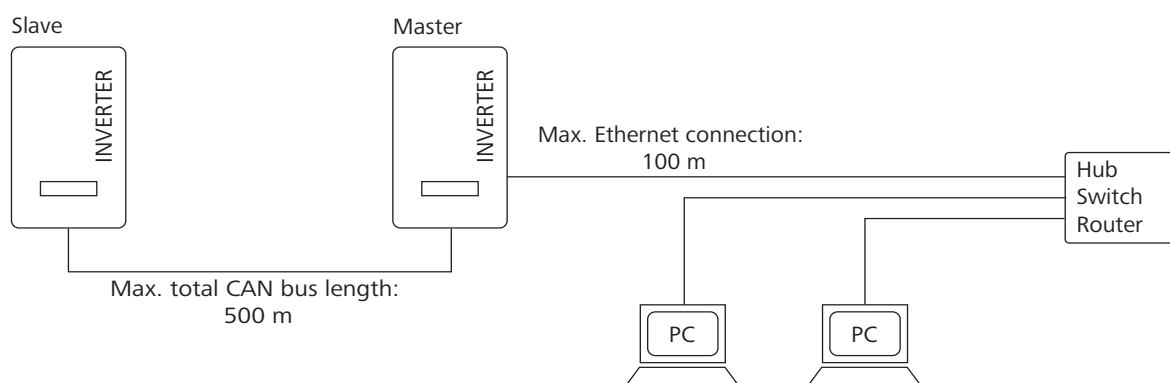

With DHCP

If a DHCP server is present in your network, you can activate DHCP on the Solar Inverter. In this case, the Solar Inverter obtains the network settings automatically. You can display the assigned IP address via the LCD display (menu Settings – Network – Ethernet).

Without DHCP

If there is no DHCP server in your network, you must set an unused IP address on the Solar Inverter (see section Solar Inverter network settings).

Ask your network administrator for the necessary settings for IP address, net mask and gateway.

After the connection is established, you can start the Sunways browser by entering the IP address of the Solar Inverter in the address line of your web browser.

Remote access via a DSL router

If a DSL connection or a network with Internet access is available, you can make the Solar Inverter accessible via the Internet.

Requirements:

- Your DSL router supports static IP address services such as www.dyndns.org.
- Your router supports port forwarding.

Procedure:

1. Connect your Solar Inverter with your DSL router. Use a CAT5 Ethernet cable with 1:1 RJ45 sockets. The master is connected to the network as standard.
2. Register free of charge, e.g. at www.dyndns.org.
3. Create a so-called alias for the access to your solar inverter, for example PTseries.dyndns.org. You can access your Solar Inverter later via this address.
4. Configure your DSL router such that the IP address is regularly reported to www.dyndns.org (follow the procedure described in the manual for your DSL router for this purpose).
5. Configure your DSL router so that it accepts queries from the Internet (e.g. via port 80) and forwards them internally to the Solar Inverter (port forwarding).
6. Also note that the port for access from the Internet set in your firewall must be enabled.



NOTE

On the Internet you will find instructions for configuring frequently used DSL routers.

Connection via the Sunways modem

A modem connection can be used to bridge longer distances during system monitoring and configuration. The Sunways modem is connected to the Solar Inverter for this purpose. The Sunways modem is available as an analog, ISDN and GSM type.

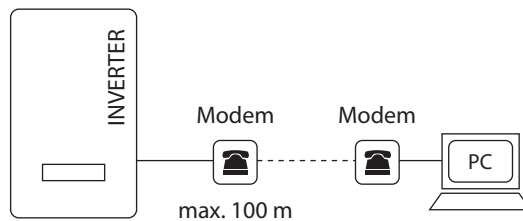

1. Connect your Solar Inverter and the remote modem with a 1:1 Ethernet connection cable, type CAT5 with RJ45 sockets.



NOTE

In a networked system, only the main unit should be connected to the remote modem as standard.

2. Connect an external modem to your PC or use the internal modem of the PC if available. For commissioning, please refer to the Sunways modem user manual.



NOTE

The following modem combinations are permitted:

- ISDN – ISDN
- analog – analog
- analog – GSM
- GSM – analog
- GSM – GSM

Connecting the Sunways modem

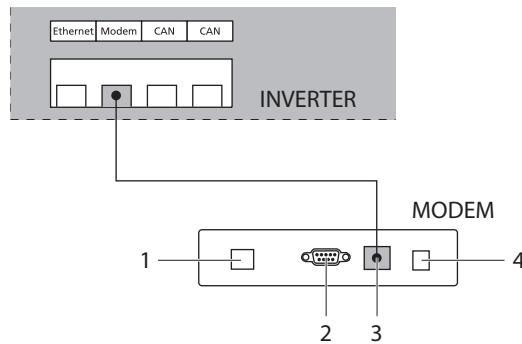

- | | |
|------------------------|---|
| 1 Telephone connection | 3 LVDS for NT, AT and PT Solar Inverter |
| 2 RS232 interface | 4 Power supply unit |

Dialling in from a PC to the Solar Inverter

To establish a connection to your Solar Inverter with a PC via the modem, you must establish a dial-up connection in Windows. The procedure under Windows® XP is shown below.

1. Run the wizard for a new connection via "Start – Settings – Network Connections".

The first selection screen is opened with "Continue".



2. Select "Connection to the network on My Computer" and confirm your choice with "Continue".

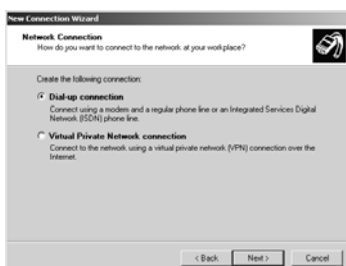

3. Select "Dial-up connection" on the next screen and click "Continue".

Operation



4. A list of the installed modems appears. Select the required modem and click "Continue".

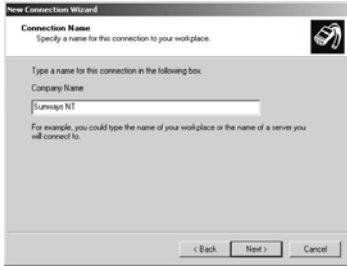

5. Enter a connection name and confirm your entry with "Continue".



6. Specify the phone number of your Sunways unit.

When entering the telephone number, you may need to include one or more digits to connect to an outside line. (An outside line is usually obtained by placing a "0" before the actual telephone number.)

Confirm your entry with "Continue".



7. In this screen you can specify whether or not this connection is to be available to all users of this PC. If in doubt specify "All users" and click "Continue".



8. Click the checkbox to place a shortcut on your desktop and click "Finish".

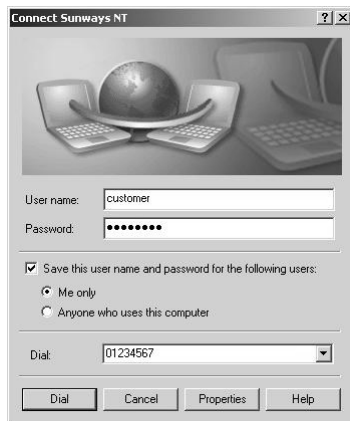

9. The connection window appears automatically after finishing the connection. (Alternatively via the icon on your desktop or via "Start – Settings – Network Connections".)

Further settings are required in the "Properties" section.

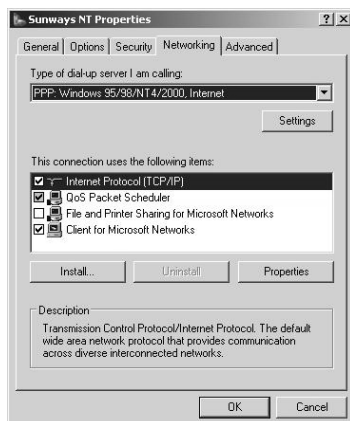

10. First select the "Network" tab and mark the entry "Internet Protocol" (TCP/IP) there.

Select "Properties".

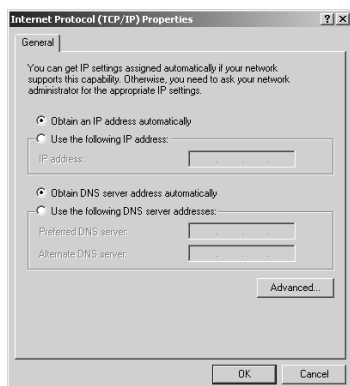

11. Enter the following data:

Obtain an IP address automatically

Obtain DNS server address automatically

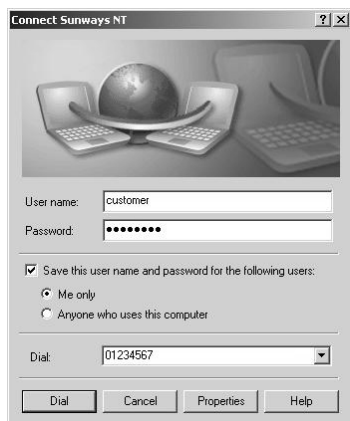

12. Enter "customer" as the user name and the standard password (*****, i.e. 8 asterisks) or the password you entered previously.



NOTE

The password matches the customer password on the unit.

13. The connection is established with "Dial". After the connection is established, you can start the Sunways browser by entering the IP address of the Solar Inverter in the address line of your web browser.



NOTE

In contrast to the normal IP address for a modem connection, the IP address of the Solar Inverter is set to **192.168.20.50** by default.

6.3 Sunways Browser

General information

The Sunways browser can be run via a standard Internet browser, e.g. Mozilla Firefox. One of the three possible connections between a PC and the Solar Inverter is required for this purpose (see section System monitoring):

- Direct connection via an Ethernet cable or internal network
- Connection via the Internet, e.g. connection of the unit to a DSL connection
- Connection via a Sunways modem

The start screen opens once the IP address of the Solar Inverter has been entered in the address line of the browser:

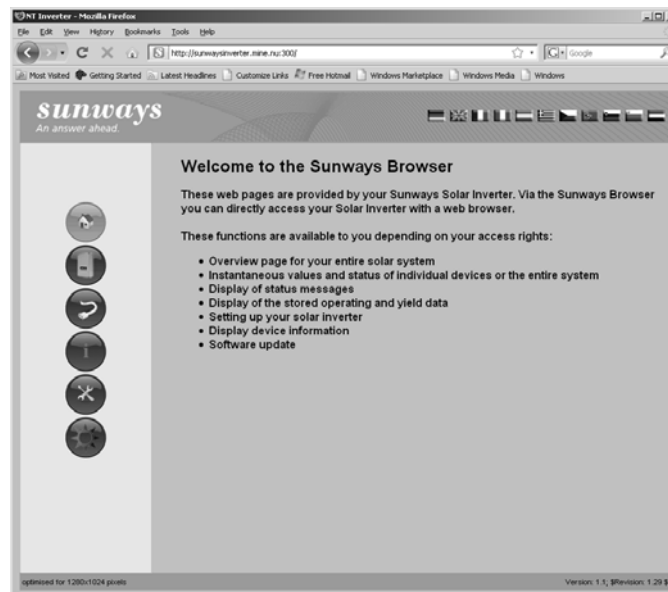

Here you can select from different languages.

The browser offers the following functions:

- Display of the operating mode and instantaneous values for a single unit or for a CAN-networked system
- Display of energy yields as 5-minute, daily, monthly, annual and total values

- 5-minute mean values of solar generator current and voltage, grid current and voltage and feed-in power
- Settings, e.g. of date/time, interface configuration, alerting options, communication parameters etc.
- Communication software update (LCD display, interfaces, communication and Sunways browser) and the control software (control and monitoring)

Access protection

The Sunways browser is provided with password protection so that unauthorised persons cannot access your Solar Inverter.

The following user data are set in the delivered state:

User: customer

Password: *****

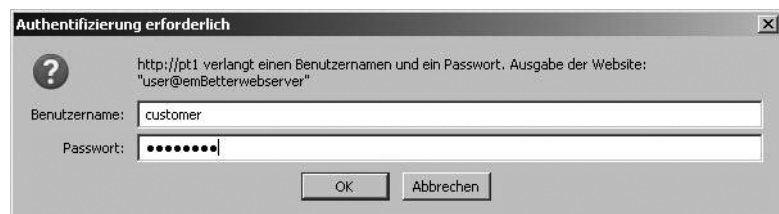

NOTE

- It is recommended that you change this password to an 8-character/digit password.
- This password is identical to the password entered via the LCD display for settings and commissioning.
- Only digits between 0 – 9 and letters between a – z and A – Z are permitted.
- The password always has 8 characters. If the password you entered has less than 8 characters, the remaining characters are filled with *.
- Example:
Your password is "Solar". This password has 5 characters. The system automatically appends three *, so that the password becomes "Solar***".
- If you cannot remember the password, you can request a device-specific password from the Technical Hotline (Tel. 49 (0)7531 996 77-577) so that you can access your Solar Inverter again. In this case, you need the serial number and the MAC address which can be found on the type label.

Overview – Menu



Home – Display of start page



Solar Inverter – Displays instantaneous values, stored operating data, and the status of the unit



Solar System – Displays a system overview with status, total output, yields and access to slaves (only available if the unit is connected with the master)



Information – Unit information, e.g. serial number



Settings and software update for the unit or the networked system



System information for your solar system such as name, capacity, geographical location, a photograph and details of the components.

Language selection

The web pages can be displayed in different languages. Click on the country flags to switch to the respective language.

Setting date/time

This function can be accessed via Settings – Date/Time. If you have selected the correct time zone and an Internet connection is available, you can automatically synchronise the time of the Solar Inverter with a time server with the NTP button.

As an alternative you can also transmit the PC time to the Solar Inverter.

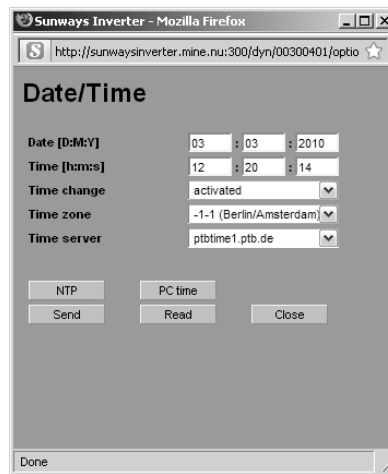

NOTE

Please note that time settings should only be made with caution, as they directly affect data logging. For example, if you set the time back by 1 hour, then the existing data will be overwritten. Check the time regularly during the maintenance intervals for correct functioning and adjust the time at least 1x year if necessary.

Software update

The software update is used to expand functions on your Solar Inverter. The communication software (for LCD display, interfaces, communication and Sunways browser), the control software or the monitoring software can be updated.

1. Call up the function "Settings – Software Update" for this purpose. This function requires entry of a password (default: ***** = 8 asterisks or the your own customer password).
2. The upper screen section shows the current software versions. If a new version is made available on our website (www.sunways.de), then you can download this file and load it via the Sunways browser. Select the file on your hard disk in the "File" field with the "Browse..." button and confirm the file dialogue with "OK".
3. The current software is copied to the Solar Inverter with the "Update" button.
4. If necessary, for older units, select between: communication software and control software.

For details, please refer to the detailed manual for software updates.

WARNING NOTICE: During a software update, the stored data of the minute values are deleted!

5. If a prompt appears to restart, please confirm with OK so that the installed software is put into operation.
6. If "Critical Error" appears, the update for the web interface must also be installed.
7. The communications unit is restarted and the new software is loaded with the "Restart" button.



Devices networked via CAN can be updated via the network. In this case the software is distributed to the slaves via the master. Further details on the update manual can be found under: www.sunways.de

Internet dial-in via modem

Modem settings

If you use a modem for the Internet connection, the modem must be set up accordingly via the Sunways browser. Therefore, first establish a connection between your PC and the Solar Inverter (see section Direct Ethernet connection).

With the web browser, you can then make the following settings in the menu "Settings – Modem":

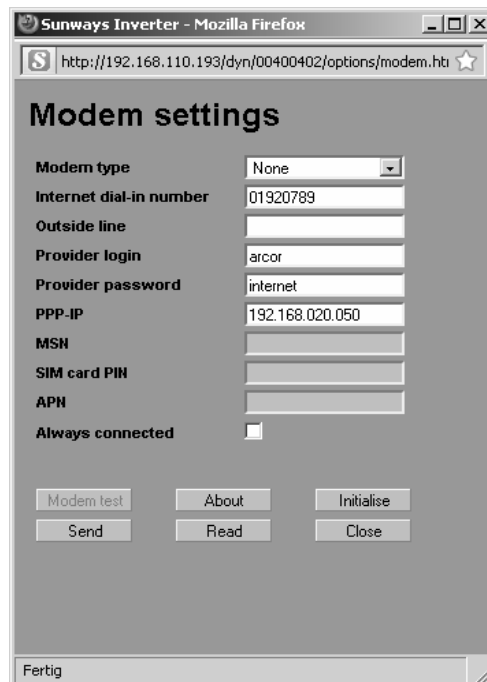

- Modem type** Selection for the modem type: Analogue, ISDN or GSM modem
- Internet dial-in number** Dial-in number of your Internet provider (ISP)
- Outside line** If you have a telephone system, you can, for example, enter a 0 here. A comma results in a dialling pause of 1 second.
- Provider Login** user name defined by your Internet provider
- Provider password** password defined by your Internet provider
- PPP-IP** you can reach the Solar Inverter by entering this IP address in your web browser. The default address is **192.168.20.50**.
- MSN** with an ISDN modem, you store the MSN of the extension to which the modem is connected here. This is usually the telephone number of the extension without the area code.
- SIM card PIN** for a GSM modem, you enter the PIN of the SIM card here.
- APN** Access point number. You can obtain the APN from your mobile communications provider.
- Always connected** Select this option if you have a GPRS mobile tariff in order to ensure that the device is always online.

**NOTE**

Please note!!! With time-based tariffs (e.g. modem connection with GSM or analog), this function can result in very high phone charges!

Function buttons

Use the "Send" option to save the settings in the Solar Inverter.

Use "Read" to display the settings currently stored in the Solar Inverter.

With "Modem Test", you can test the modem connection to the set Internet provider. You will receive feedback as to whether dialling in was successful.

Click "About" to obtain additional information about the modem.

Click "Initialise" to re-initialise the modem.

**NOTE**

- Before conducting the modem test, the settings must be stored in the Solar Inverter with "Send".
- For example, you can select inexpensive dial-in numbers for Internet providers at www.teltarif.de/internet or www.billiger-surfen.de. Here you will find not only tariff information, but also the access data (phone number, user name, password).

E-mail settings

In order for the Solar Inverter to be able to send e-mails, the e-mail settings must be stored via the Sunways browser. The settings can be accessed via "Settings – Network" in the section "E-mail settings".

**NOTE**

Requirements:

- When dialling in via modem, the correct dial-up settings must be stored (see Internet dial-up via modem).

Standard SMTP

If the standard SMTP server is activated, the e-mails are sent via a preconfigured mail server.

SMTP provider

SMTP server for sending e-mails, e.g. mail.gmx.net (max. 30 characters). Alternatively an IP address can be entered.

Operation

SMTP user	User name for your e-mail provider (generally your e-mail address), e.g. Sunways@gmx.de (max. 50 characters)
SMTP password	Password for your e-mail provider (max. 20 characters)
Function buttons	Via "SMTP Test", you can send a test message to the e-mail address stored for active alerting.



NOTE

- Before conducting the SMTP test, the settings must be stored in the Solar Inverter with Send.
- During the SMTP tests an e-mail is sent to the e-mail address stored in the system monitoring unit (active alerting). Before starting the test, check whether a valid e-mail address is stored under active alerting.
- If no login is set up on the configured SMTP server, the password field must be left empty. The login field is entered as the sender address for the e-mail. If no login is specified, the Solar Inverter sends the e-mail with a standard sender address.

Use the "Send" option to save the settings in the Solar Inverter.

Use "Read" to display the settings currently stored in the Solar Inverter.

Active alerting

General information	With active alerting, you can receive status messages (errors and warnings) for your solar system by e-mail. If a status message was active for longer than 15 minutes or occurred 5 times in one day, you will receive an e-mail at the next full hour, which is sent to the e-mail address stored in the Solar Inverter.
----------------------------	--



NOTE

The master sends the status messages of all units if they are CAN-networked.

Requirements:

- The master must be connected to the Internet via a network or modem.
- When dialling in via modem, the correct dial-up settings must be stored (see Internet dial-up via modem).
- Correct e-mail settings must be stored in the Sunways browser (see "E-mail settings").

Alerting settings	The alerting settings can be accessed with the "Settings – System Monitoring" button in the "Active Alerting" section.
--------------------------	--

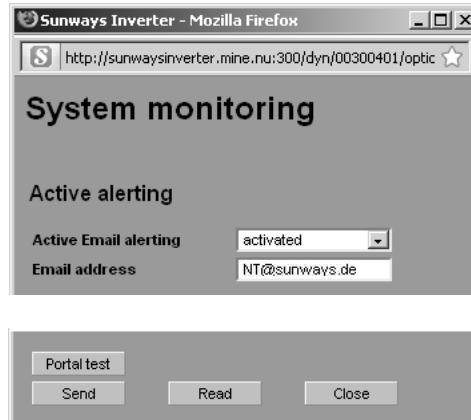
**Active e-mail alerting**

Activation or deactivation of the active alerting function.

E-mail address

In the email address field, enter the email address to which the messages are to be sent.

Function buttons

Use the "Send" option to save the settings in the Solar Inverter.

Use "Read" to display the settings currently stored in the Solar Inverter.

Sunways Portal connection**General information**

You can have the operating data of your solar system automatically sent to the Sunways portal to monitor your system via the Internet. This is possible without using a Sunways communicator.

The portal connection is configured via the Sunways browser. Following activation, the main unit automatically sends a registration e-mail containing the system data (e.g. number of units, serial number, etc.) to the Sunways portal.

After activation, the operating data for each day are sent to the Sunways portal by e-mail on a daily basis before the main unit is switched off for the night. The interval can also be set shorter as an alternative. If a change is made to your solar system (e.g. additional unit), then the change is automatically reported to the Sunways portal.

A basis access for the Sunways portal for displaying the yield data is available to every Sunways customer free of charge. Expanded functions, e.g. the set-point-actual comparison in the Sunways portal, can also be purchased for a fee.

**NOTE**

The main unit sends the status messages of all units if they are CAN-networked.

Requirements:

- The main unit must be connected to the Internet via a network or modem.
- Correct e-mail settings must be stored in the Sunways browser (see "E-mail settings")

- Correct portal settings must be stored in the Sunways browser.

Setup

Check whether you meet all requirements. Configure the specified settings if necessary via the Sunways browser according to the following procedure.

1. In the Sunways browser, call up the "Settings - System Monitoring" page
2. Tick the "Portal connection" checkbox to activate.
3. Select the send interval in the "Email interval" field. Be aware that these settings influence telephone costs depending on the type of connection.
4. In the "User e-mail" field, store the e-mail address to which the login confirmation of the Sunways portal should be sent.
5. Optionally, you can store your mobile phone number in the "User SMS" field.
6. The settings you selected are accepted by pressing the "Send" key.
7. You will immediately receive an e-mail with an activation link for the Sunways portal.
8. In the meantime, carry out a connection test to the portal by pressing the "Portal Test" button. If successful, the system ID of the Sunways portal is automatically entered in the corresponding field. You will also receive notification on the stored mobile phone number.
9. Follow the activation link in the e-mail and log on in the Sunways portal with the user name and password from your e-mail.
10. Logging on the solar system: Choose between: New login for a new installation or replacement of the unit (if the main unit has been replaced).
11. In the Sunways portal, change your login data (user name and password) in the "Administration" menu under "Password".
12. Now select the "Administration - System Data" menu. Please insert the rated power of the generator field via the "Subsystem" function.
13. If required, you can purchase the professional access to the Sunways portal via the "Administration - Contract status" menu. Comprehensive monitoring functions for your solar system are made available.

7 Maintenance

7.1 Servicing schedule

Regular maintenance is required in order to ensure sound operation of the Solar Inverter. Maintenance is carried out in accordance with the commissioning and maintenance reports of Sunways.



DANGER

- Maintenance may only be carried out by qualified staff. Dangerous voltages!
- Touching live parts can result in death.
- All electrical work must be carried out by a qualified electrician while observing the VDE regulations, national and other regulations.
- The checks must be carried out based on the recognised state of the art and the regulations specified by employers' liability insurance associations.
- The specified sequence of tasks and checks must be followed.

7.2 Maintenance interval

The PT series must be serviced once a year.

Initial service should be carried out no later than 12 months after commissioning.

The following maintenance tasks should be carried out once per calendar year.

The service must be carried out no later than 2 months after the month in which the unit was commissioned. Air inlet grilles may need to be cleaned more frequently in installation locations with increased soiling.



NOTE

The service can be undertaken by Sunways or a service partner as part of a service agreement with Sunways.

7.3 Maintenance tasks

Wiring

Visual inspection and measurement of all AC and DC cables between the module and the public grid of the energy supplier (terminals and transitions).

Solar generator connection box



DANGER

Extreme danger from electric shock!

The main DC switch in the inverter must be in the "0" position.

Measurement configuration at the inverter output of the module connection box, close the DC fuse holder for the string to be measured, record the result, fold out the fuse holder and measure other strings in the same way if required.

1. Check the open circuit voltage for each string
2. Check the short circuit current for each string
3. Measure the DC voltage
4. Measure the mains voltage
5. Connection test
6. Check the MPP status
7. Check the MPP voltage

Inverter

1. Carry out filter cleaning (IP 42, IP 54 variants)

If the filters are too dirty, replace them.

In each case, two filter mats at the top (only for IP54 variant) and two filter mats in the base of the unit should be replaced. To replace the filter mats in the base, release the bolts at the side and fold the module downwards.

2. Clean the air inlet grilles (IP 55/Outdoor variant)
3. Check the connectors. Done and OK?
4. Connection bolts checked and OK?
5. Visual inspection of the interior for assessing the electrical components.

Particular attention must be paid here to potential damage caused by small animals and insects, as it is possible for them to enter the housing through cable glands which have not been closed properly or through open front or back doors.

6. Check overvoltage protection.
7. Software updates if new software is available.
8. Grid connection: Visual inspection of the transformer housing and the electricity meter.
9. Manual current and voltage measurements with multimeter and current probe for all strings. (Voltage-proof tool at least 1000 V DC)
10. Insulation measurements for the individual strings.

A Appendix

A.1 Installation methods and cable cross-sections

This is an overview of the contents of DIN 0294-8 / EN60204-1. The data in the standard are relevant and must be used.



NOTE

- The data is based on an ambient temperature of 30°C according to test conditions and a cable temperature of up to 70°C.
- Number of wires under load: 3
- Line accumulation must be taken into account.

Reference installation methods A2, B2, C, E for fixed installation of cables and lines in and on buildings according to DIN VDE 0298-4/2003:

Installation method	Diagram	Rated current for the LS switch		
		10 mm ² Cu	16 mm ² Cu	25 mm ² Cu
Installation method A2 <ul style="list-style-type: none"> • Installation in thermally insulated walls • Multi-core or sheathed cables • Directly installed in electrical conduits or ducts 		-	-	63 A
Installation method B2 <ul style="list-style-type: none"> • Installation in electrical conduits or enclosed electrical service ducts on or in walls, or in ducts for underfloor installation • Multi-core or sheathed cables 		-	63 A	80 A
Installation method C <ul style="list-style-type: none"> • Direct installation on or in walls/slabs or in cable troughs • Multi-core or sheathed cables 		63 A*	80 A	100 A
Installation method E <ul style="list-style-type: none"> • Installation in air, on support cables or on cable racks and brackets • Multi-core or sheathed cables 		63 A*	80 A	100 A

*) not applicable for installation on wooden walls

A.2 General liability disclaimer

Although information contained in this manual has been checked with the greatest care for its accuracy and completeness, no liability whatsoever can be accepted for errors or omissions.

- Sunways AG reserves the right to change the hardware and software features described here at any time without prior notice.
- This manual may not be reproduced, passed on, copied or translated into other languages in whole or in part in any form or with any means without prior written approval by Sunways AG.
- Sunways AG shall assume no guarantee for damage caused by faulty or lost data due to incorrect operation or the malfunction of the unit, the software, additional devices or PCs.

All rights reserved. © Sunways The products named on cover page are protected by copyright and sold under licence. No part of this document may be reproduced in any form without prior written approval of Sunways.

Registered trademarks HERIC® is a registered trademark of Fraunhofer Gesellschaft, Munich.

Sunways AG
Photovoltaic Technology
Macairestraße 3 - 5
D - 78467 Konstanz
Telefon +49 (0)7531 996 77-0
Fax +49 (0)7531 996 77-444
E-Mail info@sunways.de
www.sunways.de

Technical Hotline +49 (0) 7531 996 77-577

Sunways
Photovoltaic Technology